

# INSTRUCTION MANUAL

## T412 SERIES



1MN0057 REV. 0



operates with ISO9001 certified quality system

**TECSYSTEM S.r.l.**  
20094 Corsico (MI)  
Tel.: +39-024581861

<http://www.tecsystem.it>

R. 1.6 16/12/25

ENGLISH

“Translations of the original instructions”

## INTRODUCTION

First of all we wish to thank you for choosing to use a **TECSYSTEM** product and recommend you read this instruction manual carefully: You will understand the use of the equipment and therefore be able to take advantage of all its functions.

ATTENTION! THIS MANUAL IS VALID AND COMPLETE FOR THE T412, T412 TCK CODE, T412 TCK CODE T.OFF VERSIONS.

## CONTENTS

	PAGE
1) SAFETY REQUIREMENTS .....	3
2) ACCESSORIES .....	4
3) TECHNICAL SPECIFICATIONS .....	5
4) FRONT PANEL .....	7
5) MOUNTING .....	8
6) ELECTRICAL CONNECTIONS .....	9
• T412 PT100 BACK .....	—
• T412 TCK BACK .....	—
• POWER SUPPLY .....	10
• ALARM ELECTRICAL CONNECTIONS .....	—
7) PROGRAMMING .....	—
• T412 STANDARD .....	11
• T412 CODE .....	—
• T412 CODE T OFF. ....	12
• CORRECTING THE SET VALUES .....	—
• CHECKING THE WORK PROGRAM .....	—
• TEMPERATURE SENSOR CONNECTION .....	—
• MEASUREMENT SIGNAL TRANSFER .....	13
• TEMPERATURE SENSOR DIAGNOSTICS .....	—
• TEMPERATURE DIAGNOSTICS .....	—
• L1 AND L2 RELAY RESET (FLAG) .....	—
• PROGRAMMED DATA DIAGNOSTICS .....	—
• T.MAX/T.MIN.ALL CHECK .....	14
• CHECKING THE WORK PROGRAM .....	—
• LAMP TEST .....	—
• HOLD FUNCTION .....	—
8) Pt100 EXTENSION CABLE TECHNICAL SPECIFICATIONS .....	15
9) FCD FUNCTION .....	—
10) WARRANTY CONDITIONS .....	16
11) TROUBLESHOOTING .....	—
12) EQUIPMENT DISPOSAL .....	—
13) USEFUL CONTACTS .....	17

## SAFETY REQUIREMENTS



### ATTENTION:

Read the manual carefully before starting to use the control unit. Keep the instructions for future reference.



Do not open the device, touching any internal components can cause electric shock. Contact with over 50 Volts can be fatal. To reduce the risk of electric shock, do not dismantle the back of the device for any reason. Moreover its opening would void the warranty. **Before connecting the device to the power supply, make sure that all the connections are correct.** Always disconnect the unit from the supply before any cabling modification.



Any intervention on the equipment must be entrusted to a qualified repair engineer

**Failure to comply with these instructions can cause damages, fires or electric shock, and possible serious injuries!**

### POWER SUPPLY

The T412 series has UNIVERSAL power supply, i.e. it can be supplied by 24 to 240 Vac-Vdc, irrespectively of polarity in Vdc. Before using it, make sure the power cable is not damaged, kinked or pinched. Do not tamper with the power cable. Never disconnect the unit by pulling the cable, avoid touching the pins. Do not carry out any connecting/disconnecting with wet hands. To disconnect the device, do not use objects such as levers. Immediately disconnect the device if you smell burning or see any smoke: contact technical service.

### LIQUIDS

Do not expose the equipment to splashes or drops, do not position it in places with humidity exceeding 90% and never touch with wet or humid hands. If any liquid penetrates the control unit, disconnect it immediately and contact technical service.

### CLEANING

Disconnect the power cable before cleaning the control unit, use a dry cloth to dust it, without any solvent or detergents, and compressed air.

### OBJECTS

Never insert any objects into the cracks of the control unit. If this happens, disconnect the control unit and contact an engineer.

### USE RESERVED TO QUALIFIED PERSONNEL

The purchased goods are a sophisticated electronic device that is totally unsuitable to be used by non-qualified personnel. Any intervention must be carried out by a specialist engineer.

### ACCESSORIES

The use of non-original accessories or spare parts might damage the unit and endanger users' safety. In the event of faults, contact technical service.

### LOCATION

Install the control unit indoors, in a place protected from water splashes and sun rays. Do not place near heat sources exceeding the parameters stated in this manual. Position on a stable surface, far from any possible vibrations. Position the unit as far as possible from any intense magnetic fields.

### REPAIRS

Do not open the control unit. For any fault, always use qualified personnel. The opening of the control unit and/or the removal of the series identifying label entails the automatic forfeiture of the warranty. The Warranty seal is applied to all devices, any attempt to open the unit would break the seal and cause the consequent automatic forfeiture of the warranty.

### TECHNICAL INFORMATION

Mail: [support@tecsystem.it](mailto:support@tecsystem.it) — tel: 02/4581861

## ACCESSORIES

The following objects are present inside the box:

Control unit



Start guide and QR code



2 blocks for panel mounting

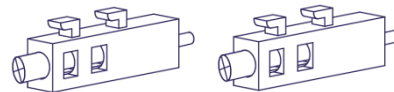

1/2 supply terminal/s 3 poles pitch 5 and (\*) PT100 sensor  
Code: 2PL0367- Screws tightening torque 0.5Nm



1 TCK sensor terminal 2 poles pitch 5 (\*)  
Code: 2PL0342 - Screws tightening torque 0.4Nm

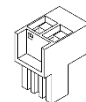

1 terminal 9 poles pitch 5 relays  
Screws tightening torque 0.4Nm

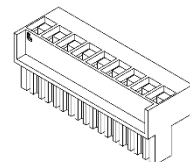

1MN0281 REV. 1

**ATTENTION:** always install the device using the terminals included in the pack. The use of terminals other than those included with the control unit might cause malfunctions.

<b>TECHNICAL SPECIFICATIONS</b>	<b>T412</b>	<b>T412 TCK CODE</b>	<b>T412 TCK CODE OFF</b>
<b>POWER SUPPLY</b>			
Supply rated values	24-240 Vac-Vdc 50/60Hz	24-240 Vac-Vdc 50/60Hz	24-240 Vac-Vdc 50/60Hz
Supply min/max values	20-270 Vac-Vdc 50/60Hz	20-270 Vac-Vdc 50/60Hz	20-270 Vac-Vdc 50/60Hz
Vdc with reversible polarities	●	●	●
<b>INPUTS</b>			
1 input for RTD sensors, Pt100 type with 3 wires	Option	NO	NO
1 input for TCK sensors	Option	●	●
Connections on removable terminal	●	●	●
Input channels protected against electromagnetic interference	●	●	●
Cable compensation for sensor	500 m (1 mm <sup>2</sup> ) Pt100	100 m (1 mm <sup>2</sup> ) Tck	100 m (1 mm <sup>2</sup> ) Tck
<b>OUTPUTS</b>			
2 alarm relays (L1 and L2) <b>SPDT</b>	●	●	●
1 fault sensor or operating failure (FAULT) relay <b>SPDT</b>	●	●	●
Output relay with 5A-250Vac-res COS $\Phi$ =1 contacts.	●	●	●
<b>DIMENSIONS</b>			
48x96 mm– din43700-depth 160mm (terminal block included)	Hole 44 x 92 mm	Hole 44 x 92 mm	Hole 44 x 92 mm
<b>TEST AND PERFORMANCE</b>			
Construction in compliance with CE regulations	●	●	●
Protection from electrical interference EN 61000-4-4	●	●	●
Dielectric strength 1500 Vac for a min. from output relays and sensors, relays and power supply, power supply and sensors	●	●	●
Accuracy $\pm$ 1% full scale value, $\pm$ 1 digit	●	●	●
Frontal film polycarbonate IP50	●	●	●

<b>TECHNICAL SPECIFICATIONS</b>	<b>T412</b>	<b>T412 TCK CODE</b>	<b>T412 TCK CODE OFF</b>
<b>TEST AND PERFORMANCE</b>			
Ambient operating temperature from -20°C to +60°C	•	•	•
Humidity 90% non-condensing	•	•	•
PPO UL 94V0 self-extinguishing housing	•	•	•
Absorption 3VA	•	•	•
Digital linearity of sensor signal	•	•	•
Protection treatment of the electronic part	Option	Option	Option
<b>DISPLAY AND DATA MANAGEMENT</b>			
1 x 7mm display with 3 digits to display temperatures and messages	•	•	•
LEDs showing the alarm (L1) or trip (L2) channel	•	•	•
LED showing the FAULT	•	•	•
LED showing PRG	•	•	•
LED showing HOLD	•	•	•
LED showing T-MAX	•	•	•
LED showing T-MIN	•	•	•
Temperature control from 0°C to 200°C for Pt100/ 0°C to 999°C for TcK	•	Only TCK	Only TCK
2 L1-L2 alarm thresholds	•	•	•
Pt100 sensor diagnostics (Fcc-Foc-FCd)	Only Pt100	NO	NO
TCK sensor diagnostics (Foc)	Only TCK	•	•
Access to programming through front keyboard	•	•	•
Automatic exit from programming after 1 minute's inactivity	•	•	•
Incorrect programming warning	•	•	•
Recall of the data set while programming	•	•	•
Channel has reached max. or min. temp. memory	•	•	•
Possibility of setting the HOLD function for the output relays	•	•	•
Programming protection with access code	NO	•	•
Setting T.Min T temperature Off alarm status	NO	NO	•

## FRONT PANEL

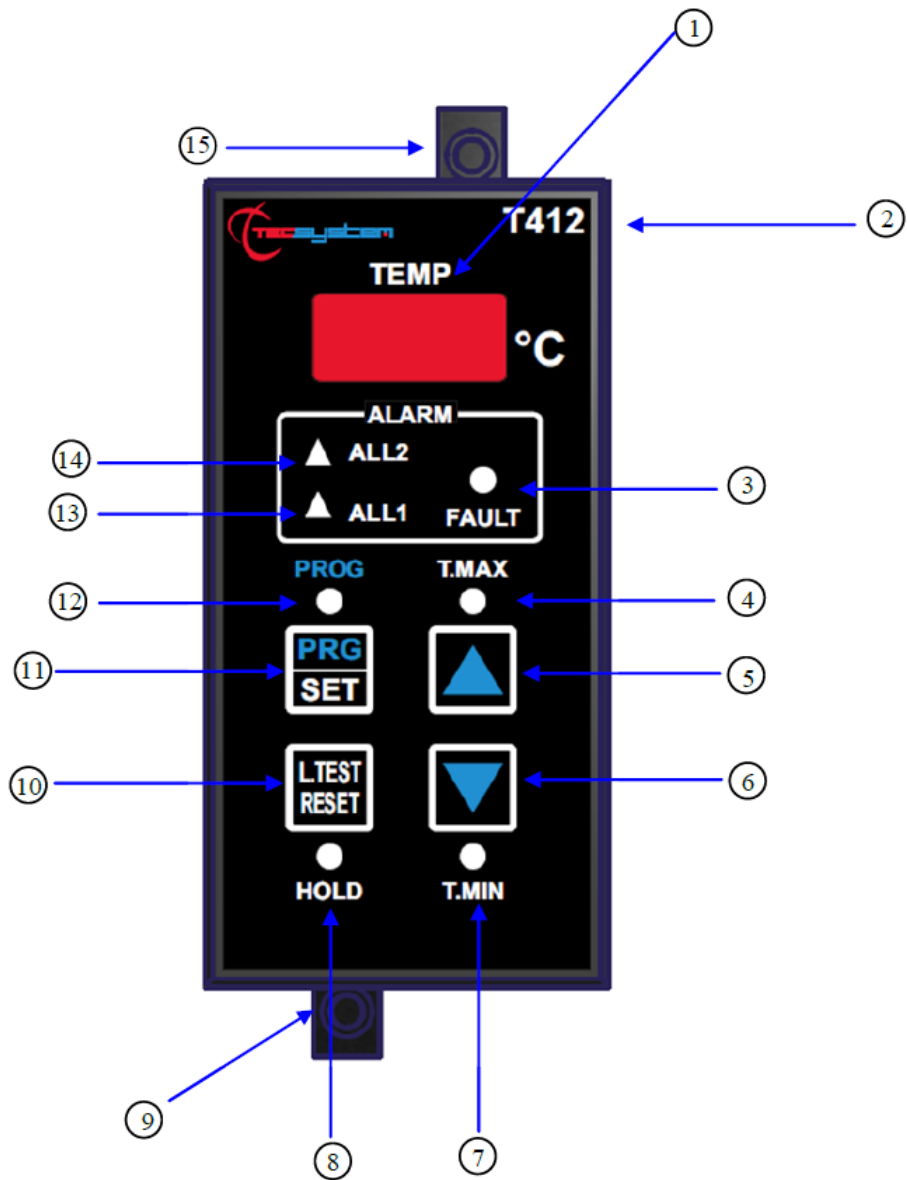

1)	3-digit display	9)	Fixing block
2)	Control unit series	10)	LTest/Reset key
3)	FAULT warning (red) LED	11)	Programming/Confirmation key
4)	T.MAX warning (red) LED	12)	PRG ON (red) LED
5)	UP (T.MAX) key	13)	ALL1 (alarm) (red) LED
6)	DOWN (T.MIN) key	14)	ALL2 (trip) (red) LED
7)	T.MIN warning (red) LED	15)	Fixing block
8)	HOLD warning (red) LED		

## MOUNTING

Drill a 92 x 44 mm hole in the panel sheet.

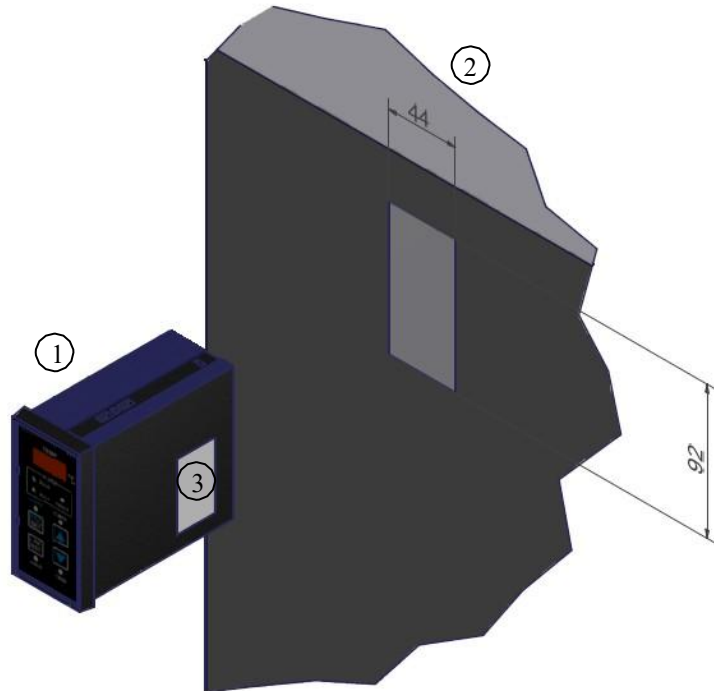

1MN0062 REV. 0

1)	Control unit	2)	Panel hole dimensions (+0.8mm tolerance)
3)	Identification label		

Fix the unit securely with the blocks supplied.

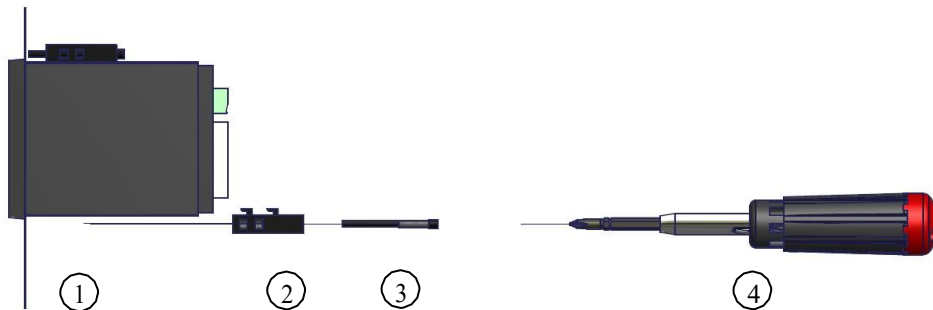

1MN0064 REV. 0

1)	Control unit	3)	Fixing screw
2)	Fixing block	4)	Crosshead screwdriver #1X100mm

# ELECTRICAL CONNECTIONS

## T412 PT100

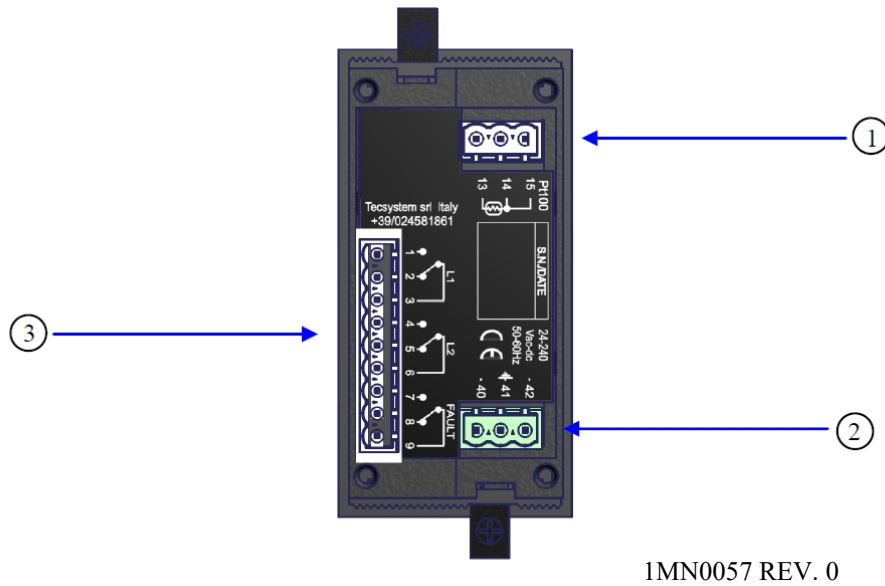

1MN0057 REV. 0

1)	PT100 sensor (white-red-red) (IEC 751 standard)	3)	Relays (L1-L2-FAULT)
2)	Power supply 24-240Vac-cc 50/60Hz		

## T412 TCK

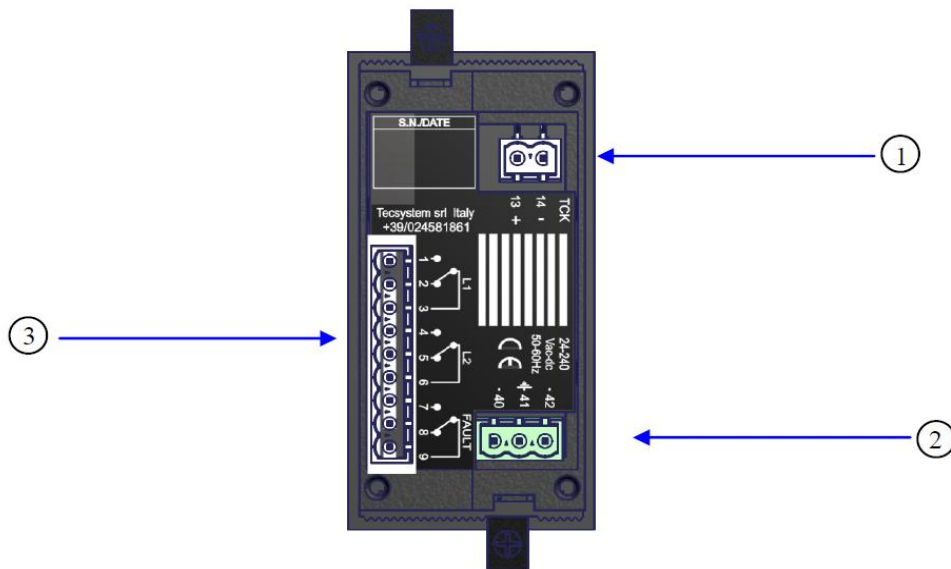

1)	TCK sensor red (-) yellow (+) conductor (ASTM E608 regulations)	3)	Relays (L1-L2-FAULT)
2)	Power supply 24-240Vac-cc 50/60Hz		

**Note:** with the power to the unit ON, the FAULT relay switches, contacts 8-9 open (NO) and 7-9 closed (NC), read paragraph *ALARM ELECTRICAL CONNECTIONS* page 10

## POWER SUPPLY

The T412 control unit has UNIVERSAL power supply, i.e. it can be supplied by 24 to 240 Vac-Vdc, 50/60 Hz irrespectively of polarity in Vdc (terminals 40-42).

This is obtained thanks to the use of a tested power supply unit, newly designed and manufactured, that frees installers from worrying about the correct Vac and Vdc supply.

Earth must always be connected to terminal 41.

When the unit is supplied directly by the secondary of the transformer to be protected, it can be burnt out by strong overvoltages. This happens if the main switch is closed and the transformer has no load (blank test). The above is much more obvious when the voltage of 220 Vac is taken directly from the secondary bars

*To protect the control unit from line overvoltages, we recommend using the electronic PT-73-220 surge limiter, designed by TECSYSTEM S.r.l. specifically for this purpose.  
Alternatively we recommend you adopt 24 Vac or, even better, 24 Vdc supply voltages.*

**If an existing control unit must be replaced with a new one, to guarantee its correct and safe operation, the sensor/relay/supply connecting terminals must be replaced with the new terminals supplied.**

## ALARM ELECTRICAL CONNECTIONS

Carry out the electrical connections on the removable terminal blocks only after disconnecting them from the unit. When the control unit is in one of the modes mentioned below, it does not monitor the temperature and the relays are all blocked.

- Vis. programming display
- PRG Programming.

The L1 and L2 relays switch only when the ALL1 and ALL2 set temperature thresholds are exceeded.

The FAULT relay switches when the unit is powered and holds till one of the following events takes place:

- Pt100 sensor fault (FCC short-circuited sensor, FOC interrupted sensor or Fcd quick temperature increase)
- TCK sensor fault (FOC interrupted sensor)
- Insufficient supply voltage.
- During the power on reset after programming (PRG) the control unit.

NOTE: do not connect the FAULT relay to the transformer tripping circuit to avoid unwanted system interruptions.

**Note: with the power to the unit ON, FAULT relay switches, contacts 8-9 open (NO) 7-9 closed (NC).**

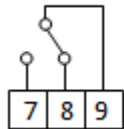

FAULT 8-9 NC: ALARM FAULT OR POWER OFF

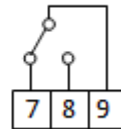

FAULT 7-9: NC POWER ON

NOTE: always disconnect the unit power supply performing any electrical connection

## PROGRAMMING











**ATTENTION:**

**We recommend you check the control unit before starting the device.**











**The default parameters set by TECSYSTEM might not suit your requirements.**

**Programming the device is the end user's responsibility: the set alarm thresholds and the enabled functions described in this manual must be checked (by a specialized technician) referring them to the application and system characteristics on which the control unit is installed.**













## T412

STEP	PRESS	EFFECT	PRESS	NOTES
1		Keep the PRG key pressed until the PRG-ON LED lights up. After PRG the ALARM threshold for ALL1 (L1) is displayed		
2		Set the desired threshold		Default 90°C
3		The ALL2 (L2) threshold is displayed		
4		Set the desired threshold		Default 119°C
5		"- - -" is displayed		
6		Select: <b>Hid</b> HOLD flag inserted (HOLD LED ON) "- - -" flag not inserted (HOLD LED OFF)		Default "- - -"
7		FCD is displayed (only Pt100 model)		
8		Set YES or NO		Default "no" (function excluded)
9		The control unit performs the lamp test and stores the settings <b>END OF PROGRAMMING</b>		

## T412 CODE

STEP	PRESS	EFFECT	PRESS	NOTES
1		Keep the PRG key pressed until the PRG-ON LED lights up."Cod" is displayed (PIN code to access programming)		
2		Set 375 to proceed		
3		The ALL1 (L1) threshold is displayed		
2		Set the desired threshold		Default 90°C
3		The ALL2 (L2) threshold is displayed		
4		Set the desired threshold		Default 119°C
5		"- - -" is displayed		
6		Select: <b>Hid</b> HOLD flag inserted (HOLD LED ON) "- - -" flag not inserted (HOLD LED OFF)		Default "- - -"
7		FCD is displayed (only Pt100 model)		
8		Set YES or NO		Default "no" (function excluded)
9		The control unit performs the lamp test and stores the settings. <b>END OF PROGRAMMING</b>		

## T412 CODE OFF

STEP	PRESS	EFFECT	PRESS	NOTES
1		Keep the PRG key pressed until the PRG-ON LED lights up. "Cod" is displayed (PIN code to access programming)		
2		Set 375 to proceed		
3		The ALL1 (L1) threshold is displayed		
2		Set the desired threshold		Default 90°C
3		The ALL2 (L2) threshold is displayed		
4		Set the desired threshold		Default 119°C
5		The T°MIN. level is displayed The LED T MIN lights up		
6		Set the desired threshold		
7		"- - -" is displayed		
8		Select: <b>Hld</b> HOLD flag inserted (HOLD LED ON) "- - -" flag not inserted (HOLD LED OFF)		Default "- - -"
9		FCD is displayed (only Pt100 model)		
10		Set YES or NO		Default "no" (function excluded)
11		The control unit performs the lamp test and stores the settings <b>END OF PROGRAMMING</b>		

**NOTE: the incorrect programming of the alarm temperature limits is highlighted by the "ERR" display (i.e. when the L1 limit is higher than the L2 limit) for 2", after which L1 is displayed again.**

### **CORRECTING THE SET VALUES**

If programming is not carried out within 60", the program resets automatically reverting to the previously stored values and the channel temperature is displayed.

### **CHECKING THE WORK PROGRAM**

To check the set protection levels, press the PRG key briefly.

By pressing the PRG key repeatedly, all the previously set values are scrolled through in sequence. After 1 minute's keyboard inactivity, the programming viewing procedure is automatically abandoned.

### **THERMOMETRIC SENSOR CONNECTION**

Each Pt100 thermometric sensor has one white and two red connectors (IEC 751 regulations).  
Each TCK temperature sensor has a red (-) and a yellow (+) conductor (ASTM E 608 regulations).

On page 9 you will find the positions on the terminal block of the connecting cables for both models.

### **MEASUREMENT SIGNAL TRANSFER**

All the cables transferring the measurement signals must:

- be separated from the power cables
- be shielded cables with twisted conductors
- have at least 0.5 mm<sup>2</sup> section
- be twisted with a 60mm pitch maximum
- be firmly fixed inside the terminal boxes
- have tinned or silvered conductors

**NOTE: to install the sensors and signal transferring cable correctly, read the sensor and SCS/Sensor installation rule manual.**

**NOTE: the use of cables not complying with the above might cause reading anomalies. It is always important to take into account that any interference on the signal lines might cause anomalies on the inputs or the sensors themselves.**

All T series control units have linearity of the sensor signal, with a maximum error of 1% of full scale value.

### **TEMPERATURE SENSOR DIAGNOSTICS (only control unit with Pt100 sensors)**

In case of failure or exceeded minimum/maximum full scale value of one of the thermometric sensors installed on the machine to be protected, the FAULT relay switches immediately with the relative warning of faulty sensor on the corresponding channel.

Fcc highlights that the sensor is short-circuited or that the minimum full scale value of the unit has been exceeded.

Foc highlights that the sensor is open or that the maximum full scale value of the unit has been exceeded.

To eliminate the message and reset FAULT switching, it is necessary to check the Pt100/TCK connections and replace the faulty sensor (if any). If the minimum/maximum full scale value has been reached, check that the ambient conditions match the control unit reading.

Note: exceeding the minimum/maximum full scale value can be caused by interference on the sensor lines; in this case we recommend that you check:

the correct installation of the sensors and above all of the extension cable (as stated in the paragraph MEASUREMENT SIGNAL TRANSFER)

the activation of the FCD function of the control unit (as stated in the FCD FUNCTION NOTES on page 15).

### **TEMPERATURE DIAGNOSTICS**

When the temperature sensor detects the temperature is 1°C higher than the value set as pre-alarm limit, relay L1 switches after about 4".

The same happens when the trip temperature threshold is exceeded and the L2 relay switches.

As soon as the detected temperature goes 1°C below the limit set for the L1 and L2 relays switching, these relays deenergize and the relative LEDs switch off.

**If the FLAG function has been programmed, the L1 and/or L2 relays shall remain energised from the moment the type of alarm is recognized to the following RESET.**

### **L1 AND L2 RELAY RESET (FLAG)**

To reset the alarm relays (if the HOLD function is ON), just press the RESET key.

### **PROGRAMMED DATA DIAGNOSTICS**

In case of failure of the internal memory or alteration of the programmed data, at start-up **Ech** is displayed with the relative warning of the Fault contact.



In this case, for safety reasons, the default parameters are loaded automatically (see the programming table on pages 11 and 12 according to the model purchased).



Eliminate the **Ech** message by pressing RESET and enter the desired values.

Finally switch the unit off and back on to check the memory works correctly, if it is damaged **Ech** will be displayed again (send the control unit to TECSYSTEM srl for repair).

### CHECK OF THE MAX/MIN T°

This function allows to view the Max and Min T° reached by the channel during normal operation since the last RESET.

STEP	PRESS	EFFECT	NOTES
1		T° Max display Press the T° Max button	The LED corresponding to the pressed key lights up
2		The max. temperature reached since the last Reset is displayed	
3		Press the T.Max key	
4		The current temperature is displayed again	

STEP	PRESS	EFFECT	NOTES
1		T° Min display Press the T.Min key	The LED corresponding to the pressed key lights up
2		The min. temperature reached since the last Reset is displayed	
3		Press the T.MIN key	
4		The current temperature is displayed again	

In T-Max or T-Min mode, press **RESET** to reset the recorded values.

After about 60 minutes' keyboard inactivity, the T.Max and T.Min LEDs automatically switch off and the function is disabled.

### CHECKING THE WORK PROGRAM

To check the set values of the temperature thresholds (L1 and L2), press the PRG button repeatedly (instantaneous):

- PROG LED OFF: program display set
- PROG LED ON: access to programming (PRG button pressed for over 4")

### LAMP TEST

Its is advisable to carry out the unit's LED test occasionally but at regular intervals. To do this, just press the L.TEST key. If one of the LEDs does not light, please return the control unit for repair.

### HOLD FUNCTION

To select the HOLD function, choose **Hid-YES** when programming. With the HOLD function ON, when the temperature exceeds the set alarm value, the Alarm relay energises and the corresponding LED lights up until the Reset button is pressed.

It is possible to reset the relay only when the temperature goes below the set value.

To exclude the HOLD function, choose **Hid- (- - -)** when programming.



### IMPORTANT WARNING

**Before carrying out the insulation test of the electrical panel the control unit is installed on, disconnect it from the power supply to prevent it from being seriously damaged.**

## Pt100 EXTENSION CABLE TECHNICAL SPECIFICATIONS

1. Cable 20 x AWG 20/19 Cu/Sn
2. Section 0.55 mm<sup>2</sup>
3. Flame retardant insulation PVC 105
4. CEI 20.35 IEC 332.1 regulations
5. Maximum operating temperature: 90°C
6. Conformation: 4 sets of three twisted and coloured conductors
7. Shield in Cu/Sn
8. Flame retardant PVC sheath
9. External diameter 12mm
10. Standard conformation in 100m coils

## FCD FUNCTION

The T series equipment boasts an innovative control function combined with the dynamic status of the **Pt100 sensor**.

**NOTE: only for the Pt100 sensor.**

Activating FCD, the control unit analyses the increase in temperature  $\Delta T$  (\*) recorded in a second (**°C/sec**).

By selecting YES, the use enables the function, the set value ( $\Delta T$ ) is 30°C/sec.

If the value detected is higher than the value set (30°C/sec.), the control unit inhibits the possible activation of the ALARM and TRIP alarms and switches the FAULT relay (7-8-9), displaying the message "**Fcd fault**".

Setting "no" disables the FCD function.

When a channel is in FAULT for FCD, the Alarm and Trip warnings are inhibited; therefore only the quick temperature increase is highlighted.

Press Reset to delete the FCD warnings and reset the FAULT relay.

### Possible FCD applications

#### Identification of a possible induced disturbance on the Pt100 sensor line

If the installation instructions are not complied with (see page 13), any disturbance on the Pt100 sensor line can cause false readings or anomalous alarms.

Corrective actions: check the installation of the sensor extension cable is in line with the instructions given in the paragraph on the measurement signal transfer on page 13.

#### Identification of a sensor fault or faulty connection

In case of a faulty connection or sensor fault, a quick positive or negative variation in temperature might occur, leading to the system tripping or the alarms of the monitored system to be triggered.

Corrective actions: check the terminals are tightened and replace the faulty sensor, if required.

#### Identification of the electrical motor rotor block

In case of temperature control of the electrical motors, the quick temperature increase might be due to a blocked rotor.

(\*) The  $\Delta T$  value shows the temperature range for each second.

## WARRANTY CONDITIONS

The purchased product is covered by manufacturer's or seller's warranty as per the "Tecsystem s.r.l.'s General Conditions of Sale" available at [www.tecsystem.it](http://www.tecsystem.it) and/or the purchase agreement drawn up.

Said Warranty is valid only when the Product fails due to reasons attributable to TECSYSTEM srl, such as manufacturing faults or faulty components.

The Warranty is invalid when the product is tampered with / modified, connected incorrectly, causing voltages outside the permitted limits, non-compliant with the use and installation technical specifications, as described in this instruction manual.

The Warranty is always ex our Corsico works, as stated in the "General Conditions of Sale".

TROUBLESHOOTING	CAUSES AND SOLUTIONS
The control unit does not switch on and the supply to terminals 40-42 is correct.	Check that: the connector is correctly inserted into its housing, the wires are tightened, there is no evidence of burning on the connectors. Disconnect the power supply, carry out the above and reconnect.
the channel is in FAULT due to FOC/FCC.	Check the connections of the Pt100 sensors, check the instructions given in the paragraphs: <i>measurement signal transfer and temperature sensor diagnostics on page 13.</i>
On startup "ECH" is displayed.	Strong disturbance has damaged the data in the memory. See the paragraph Programmed data diagnostics on page 13.
The main switch is tripped unexpectedly. The temperature is within range.	Check the temperatures recorded in T-MAX, check the instructions given in the paragraphs: <i>measurement signal transfer and temperature sensor diagnostics on page 13. Activate the FCD function.</i>
FCD warning.	See the FCD function on page 15.
Contact <i>TECSYSTEM Technical Department</i> if the problem persists.	

## EQUIPMENT DISPOSAL

European directive 2012/19/EU (WEEE) has been approved to reduce electrical and electronic waste and promote the recycling and reuse of the materials and components of said equipment, cutting down on the disposal of the residues and harmful components of electrical and electronic materials.



All the electrical and electronic equipment supplied after 13 August 2005 is marked with this symbol, pursuant to European directive 2012/19/EU on electrical and electronic waste (WEEE). Any electrical or electronic equipment marked with this symbol must be disposed of separately from normal domestic waste.

Returning used electrical devices: contact TECSYSTEM or your TECSYSTEM agent for information on the correct disposal of the devices.

TECSYSTEM is aware of the impact its products have on the environment and asks its customers active support in the correct and environmentally-friendly disposal of its devices.

## USEFUL CONTACTS

TECHNICAL INFORMATION: [support@tecsystem.it](mailto:support@tecsystem.it)

SALES INFORMATION: [info@tecsystem.it](mailto:info@tecsystem.it)

