

# INSTRUCTION MANUAL

## NT538 WS EVO

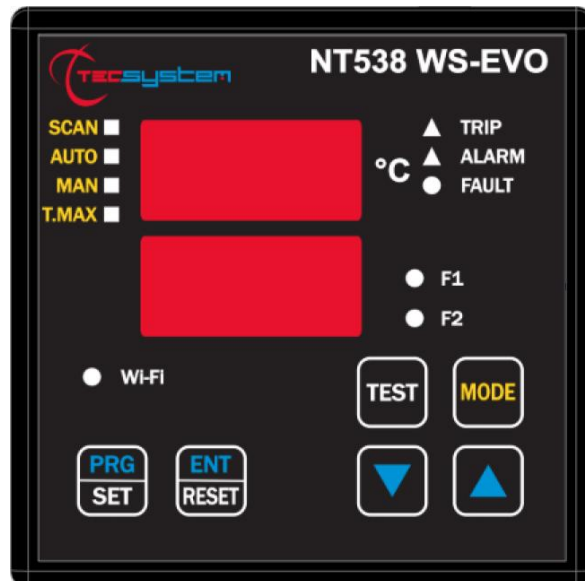

2MN0200 REV. 0



operates with ISO9001 certified quality system

TECSYSTEM S.r.l.  
20094 Corsico (MI)  
Tel.: +39-024581861

<http://www.tecsystem.it>

R. 1.3 21/01/25

ENGLISH

“Translations of the original instructions”

## INTRODUCTION

First of all we wish to thank you for choosing to use a **TECSYSTEM** product and recommend you read this instruction manual carefully: You will understand the use of the equipment and therefore be able to take advantage of all its functions.

ATTENTION! THIS MANUAL IS VALID AND COMPLETE FOR THE NT538 WS EVO MODEL CONTROL UNIT.

## INDEX

	PAGE
1) SAFETY REQUIREMENTS .....	4
2) ACCESSORIES .....	5
3) TECHNICAL SPECIFICATIONS .....	6
4) FRONT PANEL .....	8
• DISPLAY .....	9
• OPERATING PROGRAM CONTROL .....	—
• NOTES ON SCAN AND MAN FUNCTIONS .....	—
• LED TEST .....	—
• ALARM RELAY TEST .....	—
• ALARM RELAY SILENCING .....	—
5) ASSEMBLY .....	10
6) ELECTRICAL CONNECTIONS .....	11
• REAR NT538 WS EVO .....	—
• POWER SUPPLY .....	12
• ALARMS AND VENTILATION .....	—
• FAULT AND RESET MESSAGE SEQUENCE .....	—
7) PROGRAMMING .....	13
• NT538 WS EVO .....	—
• PROGRAMMING NOTES .....	14
• TEMPERATURE SENSORS .....	15
• MEASUREMENT SIGNAL TRANSFER .....	—
• TEMPERATURE SENSOR DIAGNOSTICS .....	16
• VOTING FUNCTION .....	—
• PROGRAMMED DATA DIAGNOSTICS .....	17
• TEMPERATURE DIAGNOSTICS .....	—
• COOLING FAN CONTROL .....	—
• FAN TEST .....	—

	PAGE
8) FAILSAFE FUNCTION .....	18
9) Pt100 EXTENSION CABLE TECHNICAL SPECIFICATIONS .....	—
10) FCD FUNCTION .....	19
11) NT538 WS EVO WI-FI CONNECTION .....	—
12) TECSYSTEM WEB SERVER .....	21
• HOME SCREEN .....	22
• TEMPERATURE AND ALARMS SCREEN .....	—
• SETTINGS SCREEN .....	23
• NETWORK SETTINGS .....	24
• OPTIONS .....	25
• E-MAIL SETTINGS .....	26
• TREND CHART SCREEN .....	27
• EVENT LOG SCREEN .....	28
• TREND CHART NOTES .....	29
• CSV FILE EXPORT NOTES .....	—
• PIN CODE .....	—
• STATISTICS SCREEN .....	30
• PERIODIC REPORT .....	—
13) TROUBLESHOOTING .....	31
14) WARRANTY REGULATIONS .....	—
15) EQUIPMENT DISPOSAL .....	32
16) USEFUL CONTACTS .....	—
17) UL SPECIFICATION AND RATINGS .....	32

## SAFETY REGULATIONS



### ATTENTION:

Read the manual carefully before starting to use the control unit. Keep the instructions for future reference.



Do not open the device. Touching any internal components can cause electric shock. Contact with a voltage over 50 Volts can be fatal. To reduce the risk of electric shock, do not dismantle the back of the device for any reason, furthermore opening would invalidate the warranty.

**Before connecting the device to the power supply, make sure that all the connections are correct.** Always disconnect the unit from the supply before any cabling modification.



Any work on the equipment must be entrusted to a qualified engineer.

**Failure to comply with these instructions can cause damage, fires or electric shock, and possible serious injuries!**

### POWER SUPPLY

The NT538 WS EVO control unit can be supplied by 85 to 260 Vac-Vdc, irrespectively of polarity in Vdc. Before using it, make sure the power cable is not damaged, knotted or pinched. Do not tamper with the power cable. Never disconnect the unit by pulling the cable and avoid touching the pins. Do not carry out any operations of connecting/disconnecting with wet hands. To disconnect the device, do not use objects such as levers. Immediately disconnect the device if you smell burning or see any smoke: contact assistance.

### LIQUIDS

Do not expose the equipment to splashes or drops, do not position it in places with humidity exceeding 90% and never touch with wet or damp hands. If any liquid penetrates the control unit, disconnect it immediately and contact technical assistance.

### CLEANING

Disconnect the power cable before cleaning the control unit, use a dry cloth to dust it, without any solvent or detergents, and compressed air.

### OBJECTS

Never insert any objects into the cracks of the control unit. If this happens, disconnect the control unit and contact an engineer.

### USE RESERVED TO QUALIFIED PERSONNEL

The purchased goods are a sophisticated electronic device that is completely unsuitable to be used by non-qualified personnel. Any work must be carried out by a specialist engineer.

### ACCESSORIES

The use of non-original accessories or spare parts can damage the unit and endanger users' safety. In the event of faults, contact technical service.

### LOCATION

Install the control unit indoors, in a place protected from water splashes and from the sun's rays. Do not place near heat sources exceeding the parameters stated in this manual. Position on a stable surface, far away from any possible vibrations. Position the unit as far as possible from any intense magnetic fields.

### REPAIRS

Do not open the control unit. For any fault, always use qualified personnel. The opening of the control unit and/or the removal of the series identifying label entails the automatic forfeiture of the warranty. The Warranty seal is applied to all devices, any attempt to open the unit would break the seal and cause the consequent automatic forfeiture of the warranty.

### BATTERY

Inside the NT538 WS EVO device there is a lithium manganese dioxide battery. Do not open the control unit; the battery used is maintenance-free. Do not expose the device to temperatures above or below the operating range ( **-20°C to +60°C**); do not expose it to fire (risk of explosion). In case of liquid leakage from the product and possible contact with persons (hands, eyes or other) or inhalation, contact your doctor immediately.

### FUNCTIONS

**To control the transformer correctly from a temperature point of view, enabling of the VOTING function is permitted where the load distributed between the phases of the transformer is adequately balanced.**

### TECHNICAL INFORMATION OR REPORTING INFORMATION

Mail: [ufficiotecnico@tecsystem.it](mailto:ufficiotecnico@tecsystem.it) - tel: 02/4581861

## ACCESSORIES

The following objects are present inside the box:

Control unit



Start guide and QR code



2 blocks for panel fixing  
Screw tightening torque 0.29Nm

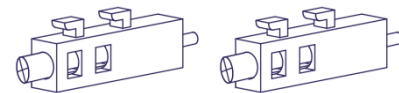

1 Terminal 3 pitch poles 5 supply  
Code: 2PL0367 - Screw tightening torque 0.5Nm



1 Terminal 12 pitch poles 5 relays  
Code: 2PL0361 - Screw tightening torque 0.5Nm



2 Terminal 12 pitch poles 3.81 sensors Pt100  
Code: 2PL0430 - Screw tightening torque 0.25Nm



1 external Wi-Fi SMA Antenna



**ATTENTION: always install the device using the terminals included in the pack.  
The use of terminals other than those included with the control unit could cause malfunctions.**

<b>TECHNICAL SPECIFICATIONS</b>	<b>NT538 WS EVO</b>
<b>POWER SUPPLY</b>	
Supply rated values	85-260 Vac-Vdc 50/60HZ
Vdc with invertible polarities	•
<b>INPUTS</b>	
8 inputs for three-wire Pt100 RTD sensors (max section 1.5mm <sup>2</sup> )	•
Connections on removable terminal boards	•
Input channels protected against electromagnetic interference	•
Thermo resistances cable compensations	500m (1 mm <sup>2</sup> )
<b>OUTPUTS</b>	
2 alarm relays (ALARM AND TRIP) SPDT	•
1 sensor or operating failure (FAULT) relay SPST	•
Output relays with 10A-250Vca-res COSΦ=1 contacts	•
2 ventilation management relays SPST FAN1 and FAN2	•
Wi-Fi Connection: frequency 2.4 GHz, protocol 802.11 b/g/n (HT20), max output 100mW, WiFi frequency 2402-2480MHZ, with removable external antenna.	Max 100m in open field
<b>DIMENSIONS</b>	
100 x 100 mm DIN 43700 prof. 150 mm (including antenna - installed at 90°C - and terminal board)	Hole 92 x 92 mm
<b>TESTS AND PERFORMANCE</b>	
Construction in compliance with the EC - RED regulations	•
Protection from electrical interferences EN 61000-4-4	•
Dielectric strength 1500 Vac for a min. between output relays and sensors, relays and power supply, power supply and sensors	•
Accuracy ±1% full scale value, ±1 digit	•
Ambient operating temperature from -20°C to +60°C	•
Permitted humidity 90% without condensate	•
Polycarbonate frontal film IP65	•
Container NORYL 94 _V0	•
Absorption 7.5VA	•

<b>TECHNICAL SPECIFICATIONS</b>	<b>NT538 WS EVO</b>
Digital linearity of sensor signal	•
Self-diagnostic circuit	•
Electronic part protective treatment	Optional
Internal battery for RTC power supply	3V 220mAh
<b>DISPLAY AND DATA MANAGEMENT</b>	
2 x 13 mm displays with 3 digits to display temperatures, messages and channels	•
3 LEDs to display the state of the alarms of the selected channel (ALARM-TRIP-FAULT)	•
4 LEDs selection of display mode (SCAN-AUTO-MAN-T-MAX)	•
2 LEDs to display the state of FAN1 and FAN2	•
Temperature control from 0°C to 240°C (*)	•
1 ALARM threshold for each channel	•
1 TRIP threshold for each channel	•
2 ON-OFF ventilation thresholds FAN1 and FAN2 in common for all enabled channels	•
Sensor diagnostics (Fcc-Foc-Fcd)	•
Data memory diagnostics (Ech)	•
Access to programming through front keyboard	•
Automatic exit from programming, display and relay test after 1 minute of inactivity	•
Incorrect programming warning	•
Selection between channels automatic scanning, hottest channel or manual scanning	•
Storage of maximum temperatures reached by channels and alarm status	•
Front key to reset the alarms	•
Voting Function	•
Fail Safe Function	•
WEB SERVER Wi-Fi Function	•
Internal clock maintenance in STATION (NTP server) and ACCESS POINT mode	•
Automatic sending of alarm activation e-mails	•
Periodic sending of channel statistics reports	•

(\*) On request, reading version -40°C to 200°C with alarm temperature control from 0°C to 200°C

## FRONT PANEL

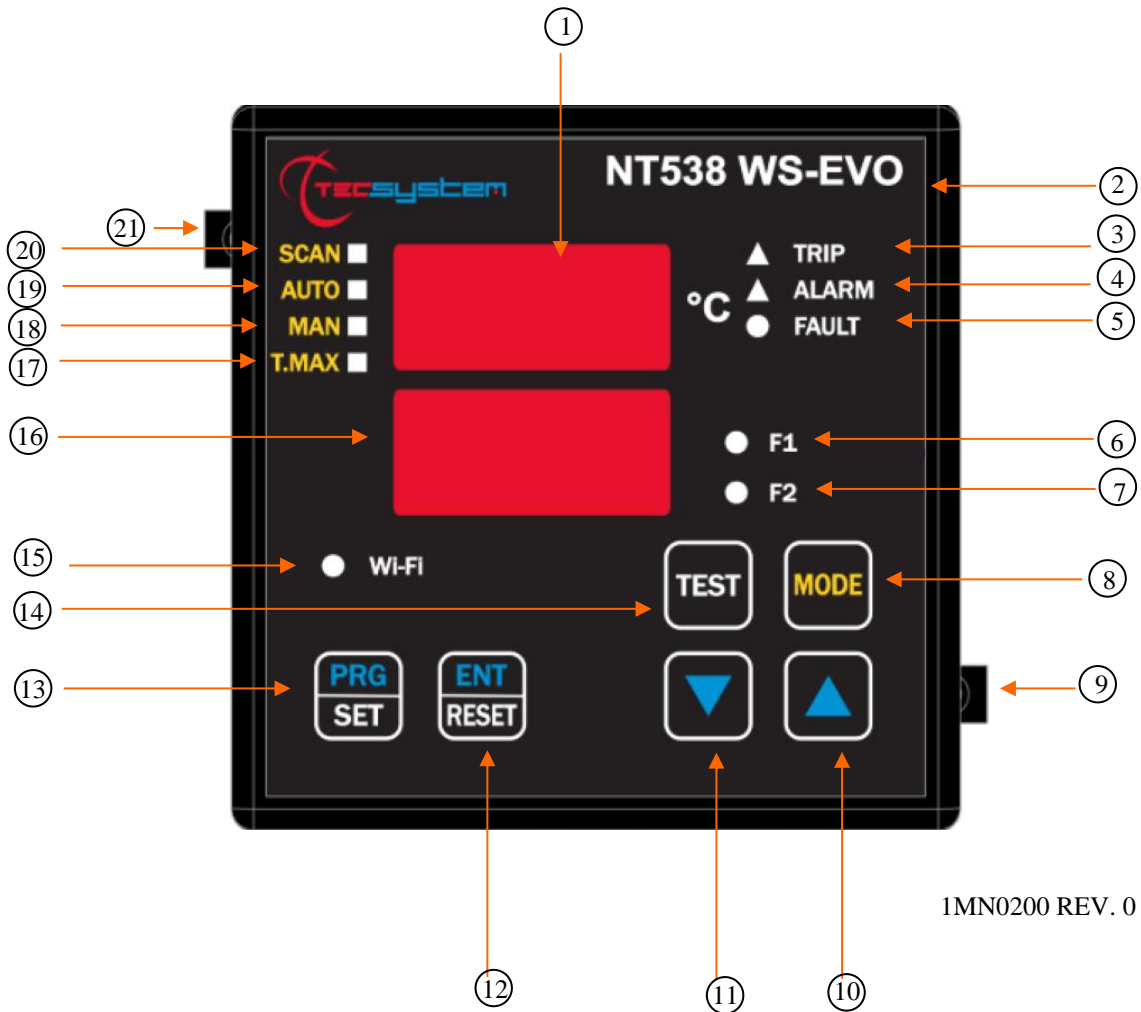

1)	3-digit temperature display	12)	Enter/Reset button
2)	Control unit series	13)	Programming/Setting key
3)	TRIP (red) LED	14)	LED/relay test key
4)	ALARM signalling (yellow) LED	15)	Wi-Fi (green) LED
5)	FAULT (red) LED	16)	3-digit channel display
6)	FAN 1 (yellow) LED	17)	T-max mode selection (red) LED
7)	FAN 2 (yellow) LED	18)	Man mode selection (yellow) LED
8)	Display mode selection key	19)	Auto mode selection (green) LED
9)	Fixing blocks	20)	Scan mode selection (yellow) LED
10)	UP key	21)	Fixing blocks
11)	DOWN key		

## DISPLAY

**The first display is dedicated to temperatures.**

**The second display to the monitored channel.**

When the device is switched on or after a reset, the NT538 control unit model, the type of probes, the temperature range, the VER "00" indication (firmware version) and the device identification code WS EVO (web server) option appear on the display.

Pressing the MODE key, the display modes can be set:

- **SCAN:** the control unit shows in scanning (every 2 seconds) all the enabled (°C) and disabled (NO) channels.
- **AUTO:** the control unit displays the hottest channel automatically.
- **MAN:** manual reading of the channel temperature using the up/down keys ▲▼.
- **T.MAX:** The display shows the maximum temperature of the channel selected with the cursor keys. In the event of a fault, the Tmax value is replaced with the type of fault stored (fcc-foc). Turning on the Trip Alarm-Fault LED warns of any events that have occurred. The recordings are always successive to the moment in which the T.Max is reset (by pressing RESET).

## OPERATING PROGRAM CONTROL

To control the protection levels programmed, press the PRG key twice to access the **VIS** programme. Repeatedly pressing the PRG key, you can scroll through all the previously loaded values in sequence.

After 1 minute's keyboard inactivity, the programming display procedure is automatically abandoned.

To stop the display, press the ENT key.

## NOTES ON SCAN AND MAN FUNCTIONS

During the SCAN and MAN modes, the operation of the NT538 can be displayed.

### 1) RUN cPU:

This message appears upon ignition of the device.

### 2) Ech Err:

This message appears when damage in the EEPROM memory is detected.

Pressing Reset will cancel the message and restore the original default parameters, listed in the programming paragraph on pages 13-14. Return the control unit to TECSYSTEM for repairs.

### 3) CAL Err:

This message appears when damage is found in the measurement circuit.

The temperature values displayed might be incorrect. Return the control unit to TECSYSTEM for repairs.

### 4) Pt Err:

This message appears when it is detected that one or more PT100 sensors are not working correctly, FOC, FCC and FCD indications in the temperature sensor diagnostics paragraph on page 16.

In case of **Err** the FAULT relay will be de-energised.

The above messages will be displayed following the 1-2-3-4 priority stated.

**NOTE:** in any display mode in case of faulty sensor failure (fcc, foc or fcd) the control unit will automatically set up in **SCAN mode (PRIVILEGED SCAN)** allowing immediately displaying of the fault condition on the relative **CHn** channel (the **Mode** key is disabled).

## LED TEST

We suggest carrying out the control unit LED test regularly.

For this operation, press the TEST key briefly; all the displays turn on for 2 seconds.

**If one of the LEDs does not work, please return the control unit to TECSYSTEM for repair.**

## ALARM RELAY TEST

This function allows you to carry out a test of the relay operation without having to use further devices. To start the test procedure, press and hold the TEST button for approximately 5 seconds: the TST indication appears for 2 seconds confirming entry into the Relays Test mode.

The lit LED indicates the relay to be tested, use the cursors ▲▼ to select the desired relay.

Press the SET and RESET keys to energise and de-energise the relay to be tested; the display will show ON-OFF.

After 1 minute's keyboard inactivity, the RELAY TEST procedure will be automatically abandoned.

To stop the RELAY TEST procedure, press the TEST key.

Alternatively it is possible to use the PT100 model simulator: SIM PT100.

**ATTENTION: accessing at the relay test mode will temporarily disable the failsafe function, the relays with function enabled switch (ALARM-TRIP-FAULT).**

## ALARM RELAY SILENCING

To silence the ALARM signal, press the RESET key: the relay will de-energise and the ALARM LED, which is on steady, will start to flash. Silencing is automatically disabled when the temperature goes below the ALARM threshold.

## ASSEMBLY

Drill a hole in the panel sheet with dimensions of 92 x 92 mm.

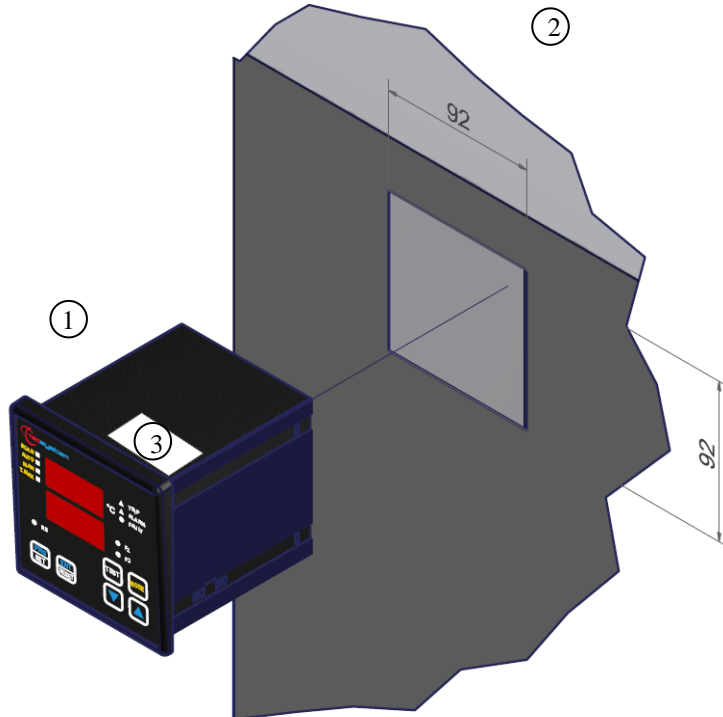

1MN0007 REV. 0

1)	Control unit	2)	Panel hole dimensions (+0.8 mm tolerance)
3)	Identification label		

Secure the appliance firmly by means of the supplied fixing blocks.

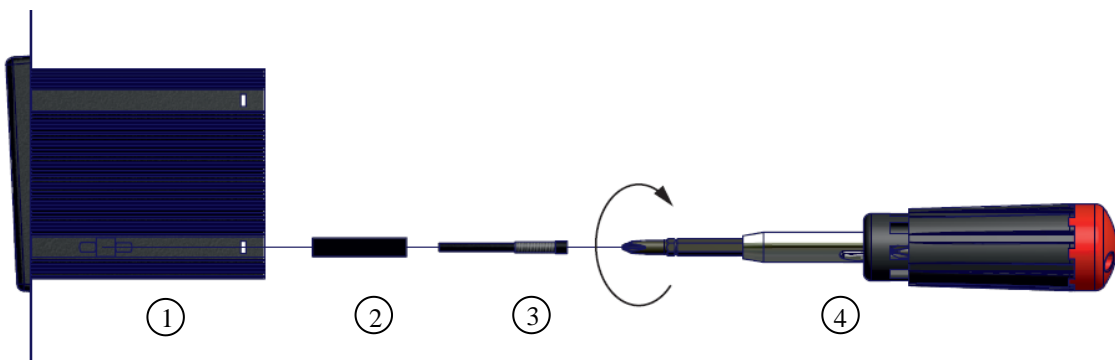

1MN0008 REV. 0

1)	Control unit	3)	Fixing screws
2)	Fixing blocks	4)	Cross-head screwdriver #1X100mm

# ELECTRICAL CONNECTIONS

NT538 WS EVO



The Wi-Fi antenna (5) is supplied with the NT538 WS EVO device. If necessary, the antenna connection can be extended using a 5 mm SMA Male to Female antenna cable.

**NOTE: Never start the device with the antenna disconnected.**

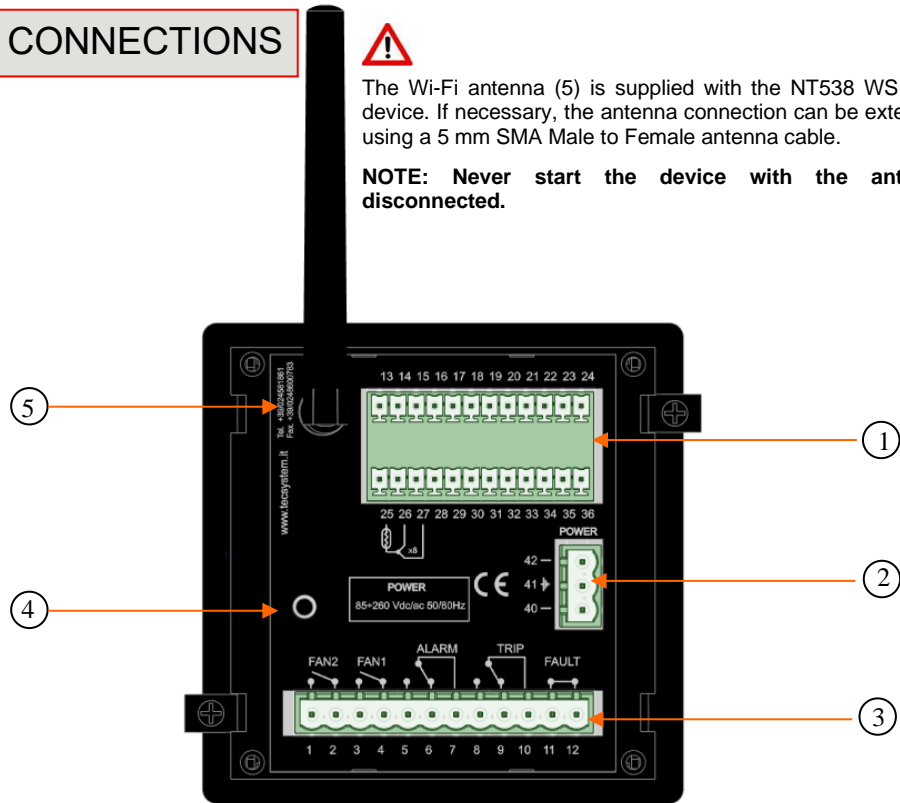

1MN0200 REV. 0

1)	Pt100 sensors (white-red-red)	4)	Access point key
2)	Power supply 85-260Vac-cc 50/60Hz.	5)	Antenna and Wi-Fi connector
3)	Relays (FAN2-FAN1-ALARM-TRIP-FAULT)		

**Note:** image relay contacts in non-alarm condition, except for the FAULT relay which switches: contacts 11-12 open (NO) contacts 11-12 closed (NC) fault condition identification. Read the Alarms paragraph page 13 and see image fault contact switching.

### RELAYS CONNECTION EXAMPLE

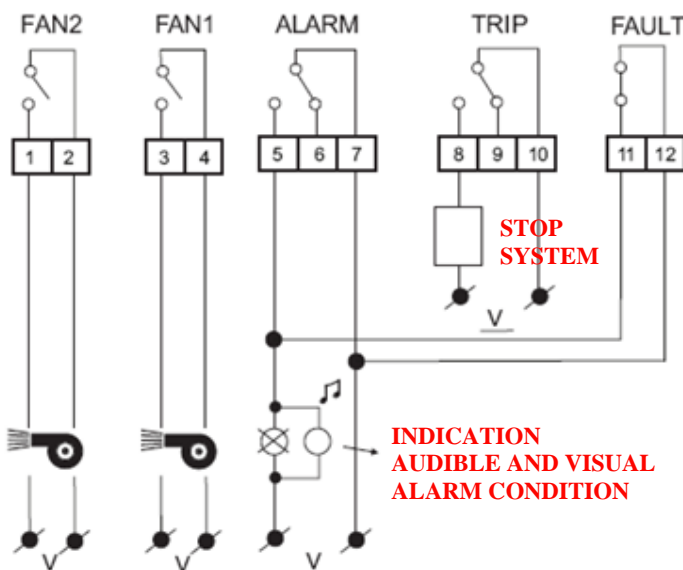

### Pt100 CONNECTION EXAMPLE

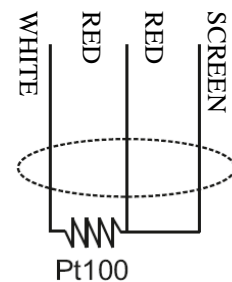

**Note:** before connecting the probes to the control unit, carefully read the paragraph measurement signal transfer on page 15.

1MN0095 REV. 0

Output relay with contacts of 10A-250Vac-res  $\text{COS}\Phi=1$ .

## POWER SUPPLY

The NT538 WS EVO can be supplied by 85 to 260 Vac-Vdc, 50/60 Hz irrespectively of polarity in Vdc (terminals 40-42).

This is obtained thanks to the use of a tested power supply unit, newly designed and manufactured, that frees installers from worrying about the correct Vac and Vdc supply.

The earthing cable must always be connected to terminal 41.

When the control unit is powered directly by the secondary of the transformer to be protected, it can be burnt out by high intensity overvoltages.

These problems occur if the main switch is closed and the transformer does not have the load (no load test).

The above is much more evident when the 220 Vac voltage is taken directly from the bars of the secondary of the transformer and there is a fixed capacitor battery for power factor correction of the transformer itself.

To protect the control unit against line overvoltages, the PT-73-220 electronic arrester, designed by TECSYSTEM S.r.l. for this specific purpose, is recommended. Alternatively, it is advisable to use 110 V AC supply voltages or, even better, 110 VDC.

**If an existing control unit must be replaced with a new one, to guarantee its correct and safe operation, the sensor/relay/supply connecting terminals must be replaced with the new terminals supplied.**

## ALARMS AND VENTILATION

Carry out the electrical connections on the removable terminal blocks only after disconnecting them from the unit.

When the control unit is in one of the modes indicated below it does not perform any thermal monitoring, moreover the relays will all be disabled. The fault contact switches and the fault LED flashes.

- Programming viewing display.
- PRG programming.
- Relay test.

The ALARM and TRIP relays only switch when the set temperature thresholds are exceeded.

The FAULT (fault) contact, programmed in active failsafe mode (default YES), opens (11-12) when the appliance is powered, only if during the access phase the control unit does not detect anomalies, and keeps the switching until when one of the following events occurs:

- Data memory fault (Ech message).
- Pt100 sensor fault (FCC short-circuited sensor, FOC interrupted sensor or Fcd quick temperature increase)
- CAL damage to the measurement circuit.
- Insufficient supply voltage.
- During the power on reset after programming (PRG), displaying the data (VIS) and test relay.

The FAULT failsafe mode can be disabled FAULT failsafe "NO" see programming step 30-31 page 14.

NOTE: in order to avoid unwanted system outages, do not connect the FAULT relay to the transformer tripping circuit.

### FAULT CONTACT OPERATION (failsafe active)

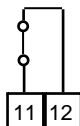

**FAULT 11-12 NC: ALARM FAULT OR POWER OFF**

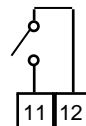

**FAULT 11-12 NO: POWER ON OR NO FAULT**

The FAN1 and FAN2 contacts can be used to control the cooling fans, or they can be inserted in the conditioning system of the transformer room, see paragraph cooling fan control on page 17.

NOTE: always disconnect the unit before performing any electrical connections.

### FAULT AND RESET MESSAGE SEQUENCE





















Find below the sequence of fault messages and RESET function condition.

- |           |                            |                          |
|-----------|----------------------------|--------------------------|
| 1) ECH    | eprom fault                | erasable message         |
| 2) CAL    | measurement circuit fault  | erasable message         |
| 3) FCD    | Temp. increase rapid fault | resettable condition     |
| 4) ERR PT | FCC or FOC sensor fault    | non-resettable condition |

# PROGRAMMING

## NT538 WS EVO

PITCH	PRESS	EFFECT	PRESS	NOTES
1		Press and hold the PRG button until the display shows PRG		
2		Select PRG SET to proceed with programming or PRG 1 to load the default values	 	PRG 1 default data
3		The display shows CH1 CH1 enabling		with YES the CH1 is enabled with NO the CH1 is disabled
4		Select YES or NO	 	
5		The ALARM threshold for CH 1 is displayed. Set the desired threshold, the Alarm LED flashes		Default 90°C
6		Set the desired threshold	 	
7		The TRIP threshold for CH1 appears, the Trip LED flashes.		Default 119°C
8		Set the desired threshold	 	
9		CH1 FAN YES appears on the display and the Fan1-2 LED flash.		fan operation info: fan control paragraph page 17
10		Select: YES FAN1 + FAN2 enabled flashing YES only FAN1 enabled flashing YES only FAN2 enabled flashing NO LED FAN1- FAN2 off	 	Default YES FAN1 + FAN2
11		Repeat the steps listed above for all the channels CH2-CH8.		
12		The display shows ON and the FAN1 LED flashes		Default 70°C
13		Set the desired threshold FAN1 ON	 	
14		OFF appears on the display, the FAN1 LED flashes		Default 60°C
15		Set the desired threshold FAN1 OFF	 	
16		The display shows ON and the FAN2 LED flashes		Default 45°C
17		Set the desired threshold FAN2 ON	 	
18		OFF appears on the display, the FAN2 LED flashes		Default 35°C
19		Set the desired threshold FAN2 OFF	 	

20		HFN (NO) is displayed The FAN1-FAN2 LEDs flash		Fan cyclic test for 5 min. every "n" hours
21		Set the desired number of hours	 	Default NO = function disabled
22		FCD (NO) is displayed		Fault for quick temperature increase (°C/sec)
23		Set the desired value (FCD info on page 19)	 	Default NO (function excluded)
24		VOT (NO) is displayed (VOTING info on page 16)		
25		Set 0-1-2-3	 	Default 0 (function excluded)
26		FLS (ALARM) is displayed Blinking ALARM LED (FAIL SAFE info on page 18)		
27		Select YES or NO	 	Default NO
28		FLS (TRIP) is displayed Blinking TRIP LED		
29		Select YES or NO	 	Default NO
30		FLS (FAULT) is displayed Blinking FAULT LED		
31		Select YES or NO	 	Default YES
32		END is displayed		End of programming
33		Press ENT to save the set data and exit programming		incorrect programming of the LED values indicated (note 6)
34		Return to step 1		

#### PROGRAMMING NOTES

- 1) The MODE key allows reversing the programming steps according to the sequence 24-22-12-1
- 2) The TEST key allows exiting programming without saving the modified data.
- 3) After 1 minute's keyboard inactivity programming is abandoned without saving the data.
- 4) During programming the control unit does not control/protect the monitored machine.
- 5) At the end of programming the control unit is restarted and the FAULT relay is disabled until the unit is fully restarted.
- 6) If pressing ENT, "Err" appears, it means that one of the following mistakes has been made:

ERR ALL. = ALARM ≥ TRIP (CH1-CH2-CH3-CH4-CH5-CH6-CH7-CH8)  
ERR FAN = FAN-OFF ≥ FAN-ON. (FAN1 OR FAN2)

The device automatically prepares itself for the programming step of the error committed

**NOTE: EVERY TIME THE CONTROL UNIT PROGRAMMING, WITH CONFIRMATION OF DATA SAVING, THE VALUES STORED IN T-MAX ARE RESET AT THE TIME OF STORING.**



#### ATTENTION:

We recommend you check the device's programming before starting the device.

The default parameters set by TECSYSTEM might not match your requirements.

Programming the device is the end user's responsibility. The settings of the alarm thresholds and enabling of the functions described in this manual must be checked (by a specialist engineer) according to the application and features of the system the control unit is installed on.

## TEMPERATURE SENSORS

Each Pt100 thermometric sensor has a white and two red conductors (CEI 75.8 standards), the figures on page 11 show the arrangement of the connection cables to the control unit in the terminal board. Each channel can be independently programmed with two alarm thresholds (alarm and trip).

## MEASUREMENT SIGNAL TRANSFER

All the Pt100 measurement signal transfer cables must strictly comply with the following rules:

1. Every Pt100 must be connected with a three-wire cable with a minimum section of 0.35mm<sup>2</sup> and a maximum of 1 mm<sup>2</sup>.
2. The extension cable must be screened with tinned copper braid with an 80% cover
3. Conductors must be twisted, maximum recommended step 60mm
4. The cable screening must only be earthed with a termination, preferably on the control unit side.
5. The sensors' signal transfer cable must not be near electrical cables, either low or medium-high voltage.
6. The Pt100 cable and the signal transfer cable must be laid in a straight line, without any winding.
7. Any caps used to butt conductors must be crimped properly to avoid false contacts.

**NOTE: for correct installation of the probes and the signal transport cable, consult the SCS/PROBE installation rules manual.**

### What may happen when installation rules are not complied with.

1) The electrical field propagating from the power line of another circuit couples capacitively with the conductors (in particular with unscreened cables). The effect of this coupling creates a signal that overlaps the signal transmitted by the nearby conductors, causing incorrect readings.

2) The variations in magnetic flux in the power lines may induce an electromotive force on the signal transferring cables (in particular non-twisted cables), that, being a closed circuit, generates a current. This interference current, multiplied by the circuit resistance, gives a voltage value that overlaps the signal to be transmitted, distorting the sensor measurement.

3) False contacts can alter the signal with the consequent variation in the temperature detected.

In specific cases, when the rules for connecting the Pt100 sensors are not complied with, the following anomalies can occur between the SCS box and the temperature control unit:

- a) incorrect temperature readings, alarms or anomalous tripping
- b) mechanical/electrical fault of the Pt100 sensors
- c) damage to the Pt100 inputs of the control unit.

TECSYSTEM S.r.l. has designed its own special cable to transfer the measurement signals, CEI-compliant, with all the protection requirements provided for mod. CT-ES

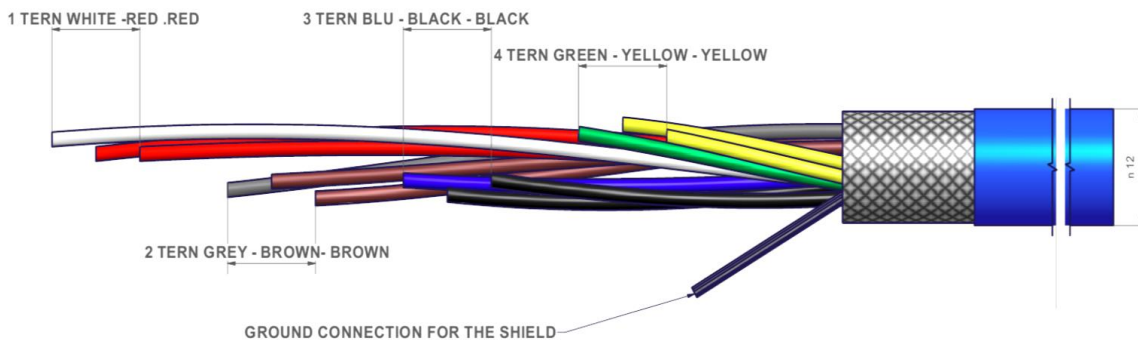

**NOTE:** the use of cables not complying with the above could cause possible reading anomalies. It is always important to take into account that any interference on the signal lines might cause anomalies on the Pt100 inputs (CH1-CH2-CH3-CH4.....CH8.) or on the sensors themselves.

All "NT" series control units have linearity of the sensor signal, with a maximum error of 1% of full scale value.

## TEMPERATURE SENSOR DIAGNOSTICS

In case of failure or exceeded full scale value of one of the thermometric sensors installed on the machine to be protected, the FAULT relay opens immediately with the relative warning of faulty sensor on the corresponding channel.

Fcc indicates sensor in short circuit or exceeding the minimum full scale value of the control unit -8°C (for version 0° ÷ 240°C) and -48°C (for version -40°C ÷ 200°C)

Foc indicates sensor interrupted or exceeding the maximum full scale value of the control unit 243°C (for version 0° ÷ 240°C) and 203°C (for version -40°C ÷ 200°C)

To eliminate the message and to restore the Fault opening, check the connections of the Pt100 and replace the faulty sensor if necessary. In case the minimum/maximum full scale value has been reached, make sure that the environmental conditions correspond to what is indicated by the control unit.

Note: exceeding the minimum/maximum full scale can also be caused by possible disturbances on the sensor lines, in this case the following are recommended:

Check correct installation of the sensors and especially of the extension cable (as indicated in the paragraph MEASUREMENT SIGNALS TRANSFER).

Activation of the functions: VOTING (below) or FCD (on page 19) must always be operated taking into account the working conditions of the system.

CAL message display: the indication appears when the measurement circuit is damaged. The temperature values displayed might be incorrect. Return the control unit to TECSYSTEM for repairs.

### VOTING FUNCTION

The voting function derives from the redundancy concept that consists in duplicating the components of a system to increase their **reliability**.

#### How does VOTING work?

Using the principle indicated, use the installed probes to monitor operation of the controlled electrical machine, but at the same time ascertain correct functioning of the probes themselves, discriminating any false alarms (generated by installation errors or failures).

The enabling of **VOTING** can be performed by choosing one of the three selection modes “1-2-3”. The control unit performs a comparison of the temperature values recorded on the monitored channels, enables the switching of the release contact (**TRIP**) only if it is detected exceeding the **TRIP** threshold on at least two channels in the same period T.

By selecting **VOTING “NO”** the function will be disabled.

The selection tables below show the combinations of channels with active voting available. For greater flexibility in two combinations we have provided channels with voting enabled and others with disabled voting.

- Voting enabled: The TRIP contact switches only if at least two channels have exceeded the TRIP threshold.
- Voting disabled: The TRIP contact switches when the individual channel exceeds the TRIP threshold.

Selection 1	Selection 2	Selection 3
VOTING ENABLED CH1... ..CH3	VOTING ENABLED CH1.... CH6	VOTING ENABLED CH1.... CH8
1	1	1
2	2	2
3	3	3
VOTING DISABLED CH4..CH8	4	4
4	5	5
5	6	6
6	VOTING DISABLED CH7..CH8	7
7	7	8
8	8	

Note: switching the **ALARM** contact will in any case indicate that the alarm threshold has been exceeded on each individual channel.

To enable the Voting function, read the programming section on pages 13-14.



**Attention: To control the transformer correctly from a temperature point of view, enabling the VOTING function is allowed where the load distributed between the phases of the transformer is adequately balanced. In addition, any conditions of FAULT: FCC-FOC-FCD on two or more channels, with active voting, can determine the TRIP contact inhibition.**

### **PROGRAMMED DATA DIAGNOSTICS**

In case of failure of the internal memory or corruption of programmed data, just after switching on, **Ech** appears with the relevant Fault contact signal.

In this case, for safety reasons, the default parameters are loaded automatically (see programming table on pages 13-14).

Eliminate the **Ech** indication by pressing RESET and run programming to enter the desired values.

Finally switch the unit off and back on to check the memory works correctly, if it is damaged **Ech** will be displayed again (send the control unit to TECSYSTEM srl for repairs).

### **TEMPERATURE DIAGNOSTICS**

When one of the thermometers detects a temperature higher than 1 ° C with respect to the pre-set value as the alarm limit, after approximately 5 seconds the **ALARM** relay switches and the channel **ALARM** LED (CH*n*) switches on.

When the trip temperature limit is exceeded, after approximately 5 seconds the **TRIP** relay switches and the channel **TRIP** LED (CH*n*) switches on.

As soon as the recorded temperature returns to values equal to or lower than the limit set for the **ALARM** and **TRIP** relays switching, these relays de-energise and the corresponding LEDs switch off.

The values of **ALARM** and **TRIP** are kept in the internal memories: they can be recalled by entering the Vis modes (displaying programmed parameters) and modifiable in the PRG mode (programming).

### **COOLING FAN CONTROL**

The NT538 WS control unit is fitted with two FAN contacts (FAN1 and FAN2) and, if programmed correctly, can control the fans switching ON and OFF to cool the controlled system.

The high flexibility of the NT538 WS EVO is used to choose, for each channel, an operating mode to manage the contacts of FAN1 and FAN2. While programming the individual enabled channel, there will be a prompt to select one of the following FAN activation modes, dedicated to that channel:

- **YES FAN1 + FAN2 enabled flashing**

The selected channel, CH *n*, will enable the switching of both contacts FAN1 and FAN2 in relation to the ON - OFF thresholds programmed for FAN1 and FAN2.

- **YES only FAN1 enabled flashing**

The selected channel, CH *n*, will enable switching of the FAN1 contact in relation to the ON - OFF thresholds programmed for FAN1.

- **YES only FAN2 enabled flashing**

The selected channel, CH *n*, will enable switching of the FAN2 contact in relation to the ON - OFF thresholds programmed for FAN2.

- **NO FAN1 + FAN2 disabled flashing**

The FAN function on the selected channel, CH*n*, is disabled. No FAN threshold is associated with the selected channel.

The thresholds of FAN1: (ON - OFF) and FAN2: (ON - OFF) are common for all enabled CH *n* channels, programmable in steps 12-19 of programming page 13.

**FAN1: (e.g.. ON at 70°C - OFF at 60°C)**

**FAN2: (e.g.. ON at 45°C - OFF at 35°C)**

The ON and OFF values are programmable according to the range of the device, FAN ON must always be at least 1°C higher than the recommended  $\Delta$  FAN (ON\_OFF) +10°C.

The FAN 1/ 2 LED lights up when the temperature exceeds 1°C the FAN ON threshold, the corresponding relay switches, and turns off when the temperature goes below 1°C the FAN OFF threshold, the corresponding relay switches.

### **FAN TEST**

It is possible, by programming (**HF*n***), to make sure that the fans are operated for 5 minutes every *xxx'* hours, regardless of the temperature values of the columns or the environment (e.g.: with HF*n* = 001 the fans are activated for 5 minutes every hour).

This function is designed to periodically check the operation of the fans and of their control equipment.

Setting **NO**, this function is inhibited.

To enable the HF*n* function, read the programming section on pages 13-14.



### **IMPORTANT INFORMATION**

**Before carrying out the isolation test of the electrical panel the control unit is installed on, disconnect it together with the sensors from the power supply to prevent it from being seriously damaged.**

## FAIL SAFE FUNCTION

The NT538 WS EVO control unit has the selection n.o (normally open contact)/n.c (normally closed contact) for the ALARM, TRIP and FAULT relays, programming steps from 26 to 31 page 14. Selecting the YES/NO setting introduces the Fail Safe and No Fail Safe functions.

### ALARM AND TRIP

By setting NO (NO Fail safe) the normally open contacts are in positions 5-7 Alarm and 8-10 Trip, they switch only when the pre-set temperature limits are reached.

By setting YES (Fail safe), the normally closed contacts are in positions 5-7 Alarm and 8-10 Trip, they switch only when the pre-set temperature limits are reached or as a result of no voltage.

### FAULT

By setting YES (Fail safe), contact 11-12 is positioned as normally open, switches (closed) when a fault condition is identified; see paragraph on alarms and ventilation on page 12.

Setting NO (NO Fail safe) the contact 11-12 is positioned as normally closed, switches (open) when a fault condition is identified; see paragraph on alarms and ventilation on page 12.

If the fail safe function is disabled on the fault contact, the control unit will no longer be able to signal the fault due to power failure. In this case it is advisable to enable the Fail safe on the ALARM contact for the afore-mentioned indication.

NOTE: NOTE: when the control unit is in one of the modes indicated below, it does not perform any thermal monitoring, moreover the relays will all be disabled the FAULT led will flash.

- Vis. display programming.
- PRG programming.
- Test of the relays.

The FAIL SAFE function is temporarily disabled and the FAULT relay switches.

**ATTENTION: accessing at the relay test mode will temporarily disable the failsafe function, the relays with function enabled switch (ALARM-TRIP-FAULT).**

## TECHNICAL SPECIFICATIONS OF THE EXTENSION CABLE FOR Pt100

1. Cable 20 x AWG 20/19 Cu/Sn
2. Section 0.55 mm<sup>2</sup>
3. Flame-protection insulation PVC105
4. Standards CEI 20.35 IEC 332.1
5. Maximum operating temperature: 90°C
6. Configuration: 4 triples of three twisted and coloured conductors
7. Screen on Cu/Sn
8. Fireproof PVC sheath
9. Outer diameter 12 mm
10. Standard configuration in 100 m coils

## FCD FUNCTION

The NT series equipment boasts an innovative control function combined with the dynamic status of the Pt100 sensor.

Activating FCD, the control unit analyses the increase in temperature  $\Delta T$  (\*) recorded in a second ( $^{\circ}\text{C}/\text{sec}$ ).

Enabling the function, the user can select the value ( $\Delta T$ ) from a minimum of  $1^{\circ}\text{C}/\text{sec}$  up to a maximum of  $30^{\circ}\text{C}/\text{sec}$ . If the measured value is higher than the value set by the user, the control unit inhibits any activation of the ALARM and TRIP alarms and activates the switching of the FAULT relay (11-12), signalling on the display "fault for Fcd".

e.g. setting the function to  $5^{\circ}\text{C}$ , the fault switching for FCD will only be activated if the control unit detects an increase  $\Delta T$  higher than  $5^{\circ}\text{C}$  in one second on the monitored system.

Setting "no" the FCD function is disabled.

When a channel is in Fault for FCD, the relative alarm and trip signals are inhibited on the single channel; therefore only the anomaly of excessively rapid increase of the temperature is signalled.

Press Reset to cancel the FCD signals of all the channels and reset the relay fault.

### Possible applications of FCD

#### Identification of a possible induced interference on the Pt100 sensor line

If the installation instructions are not complied with (see page 15), any interference on the Pt100 sensor line can cause false readings or anomalous alarms.

Setting the FCD function in a temperature range of between  $1^{\circ}\text{C}$  and  $10^{\circ}\text{C}$  ( $5^{\circ}\text{C}$  recommended), the effects caused by false readings can be suppressed and the alarm relay activation can be prevented, as shown above.

Corrective actions: check the installation of the sensor extension cable is in line with the instructions given in the paragraph on the measurement signal transfer on page 15.

#### Identification of a sensor fault or faulty connection

In case of a faulty connection or sensor fault, a quick positive or negative variation in temperature might occur, leading to the system tripping or the alarms of the monitored system to be triggered.

In this specific case we recommend the FCD function to be set in a temperature range of between  $10^{\circ}\text{C}$  and  $20^{\circ}\text{C}$ .

Corrective actions: check the terminals the sensor is connected to are tightened and replace the faulty sensor, if required.

#### Identification of the electrical motor rotor block

In case of temperature control of the electrical motors, the quick temperature increase might be due to a blocked rotor.

In this specific case, it is advisable to set the FCD function in a temperature range of between  $20^{\circ}\text{C}$  and  $30^{\circ}\text{C}$ . This setting is recommended in order to avoid activation of the FCD function during the motor starting phase, i.e. where the increase  $\Delta T/\text{sec}$ . has a very rapid variation.

(\*) The  $\Delta T$  value shows the temperature range for each second.

**NOTE: it is advisable not to enable the FCD function with VOTING active.**

## NT538 WS EVO WI-FI CONNECTION

The NT538 WS EVO control unit has a built-in **WEB SERVER** that is accessible via Wi-Fi connection.

What is needed to access the **NT538 WS EVO** control unit?

To access the web server a device with a Wi-Fi connection and an Internet browser is needed.

How to connect on the first start? "**Access Point**" mode

**Power the control unit by keeping the button on the back pressed for approximately 5 seconds.**

**NOTE: Access point key**

The access point key allows the user to temporarily access the web server in the "**Access Point**" mode, forcing operation with the IP address 192.168.8.8.

How it works:

With the control unit off, keep the access point button pressed, then power the device and release the button after approximately 5 seconds

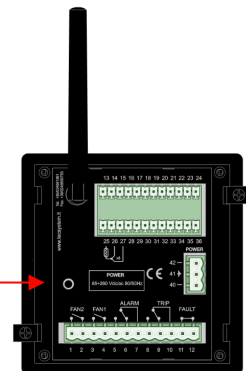

Launch the search for Wi-Fi networks from your device (PC, Smartphone or Tablet).

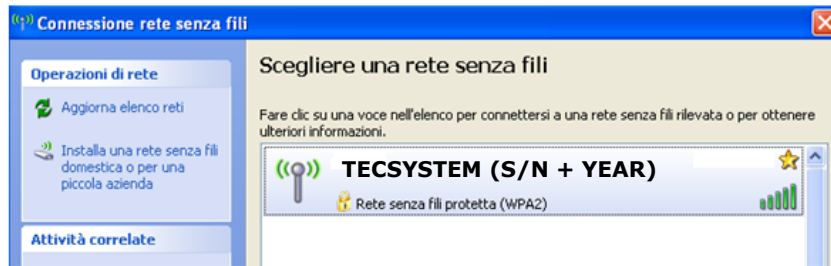

NOTE: the name of the network to connect to consists of: **TECSYSTEM** followed by the serial number **S/N** of the device and the year of production (**20 = 2020**), **values shown on the identification label of the product purchased**.

Select the **TECSYSTEM (S/N + YEAR)** network.

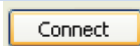
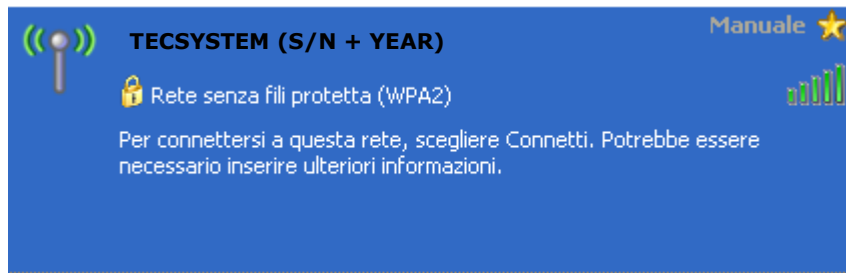

Click on **CONNECT**

The **TECSYSTEM** network requires the insertion of a digital network key: **TECSYSTEM** in the **network key** window, repeat the operation in the **network key confirmation** window.

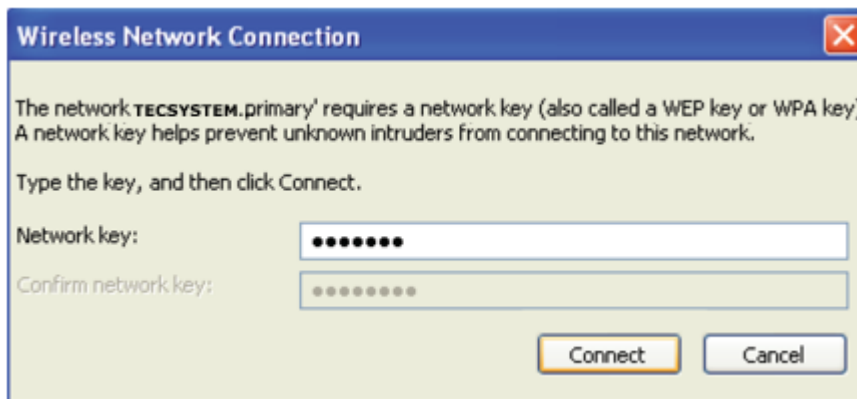

Click on **CONNECT**

Once the connection is established, your device will indicate **Connected TECSYSTEM**.

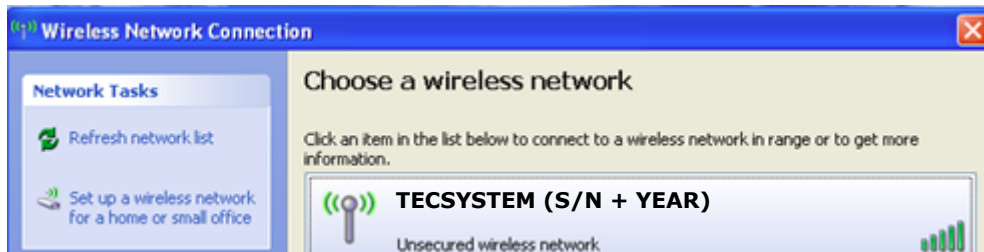

NOTE: Connecting to the **TECSYSTEM** network will result in automatic disconnection from other networks; for devices such as Smartphones or Tablets it may be necessary to disable the data connection.

Having connected to the **TECSYSTEM network (S/N + YEAR)** open your browser program and type in the address 192.168.8.8, that follows on page 21.

## TECSYSTEM WEB SERVER

Through the Wi-Fi connection, the TECSYSTEM WEB SERVER interface allows the user to access all the information present on the web server integrated in the NT538 WS EVO.

To take full advantage of the product features it is advisable to connect the NT538 WS to a Wi-Fi network (STATION mode). The Wi-Fi connection will allow you to manage multiple control units under a single network and to control them from any device connected to the network. The NTP Server setting (time.google.com or other), see STATION options page 24, will allow automatic updating of date and time.

The **STATION** or **ACCESS POINT** operating mode is shown in the footer on the HOME screen:

- **WI-FI CONNECTED TO - NETWORK NAME (dBm signal reception level) - MODBUS RUNNING (STATION))**
- **WI-FI DISCONNECTED - MODBUS RUNNING (ACCESS POINT)**

NOTE: in the **Access point** functions, the device automatically keeps the date and time, through a back-up battery, set at the first start-up. Accessing the "Options" page it will be possible to set the date/time data manually, see page 25.

The data collected on the web server is divided into 7 screens:

- **Presentation screen** (Device serial number, firmware version and web server version)
- **Home screen** (screen selection pages)
- **Temperatures and alarms screen** (measured temperatures and channel status)
- **Settings screen** (NT538 device programming and web manager settings)
- **Graphics screen** (display of temperature graphs and CHn channel data export)
- **Event log screen** (display and events export)
- **Statistics screen** (view channel statistics)

Open your browser and enter the address: **192.168.8.8**

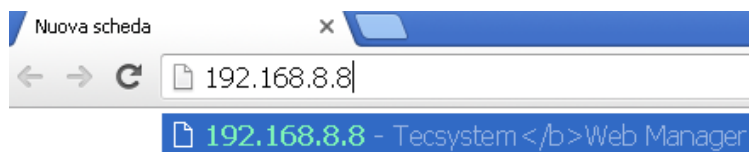

Select **192.168.8.8 Tecsystem Web Server**, press **ENTER**.

The web manager's presentation page will appear for a few seconds, showing the model of the control unit, the serial number of the device and the year of production, its firmware version and the web server version.



## HOME SCREEN

The home screen allows the user to identify the cabin and to select the various screens.

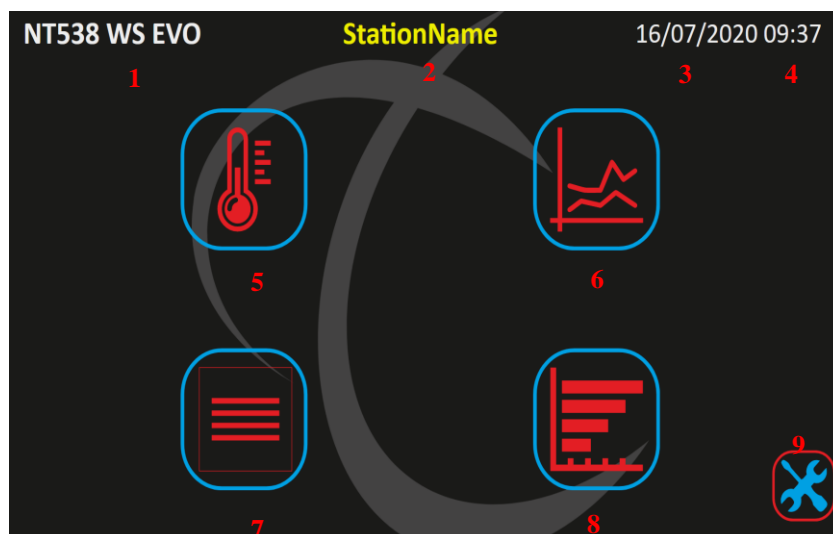

The management screen shows the following information:

1	Control unit model	6	GRAPHICS screen selection key
2	Station Name or monitored cabin (*)	7	EVENT LOG screen selection key
3	Reference date	8	STATISTICS screen selection key
4	Reference time	9	SETTINGS screen selection key
5	TEMPERATURES AND ALARMS screen selection key		

(\*) The Station Name indication can be customised by the user in the options- labels settings screen, see page 25. Pressing the selection keys 5-6-7-8-9 it is possible to access the various screens; the web server will display only one screen at a time.

## TEMPERATURE AND ALARMS SCREEN

The temperatures and alarms screen shows the operating status of each channel, i.e.: the temperature detected by each channel, the FCD-FOC-FCC sensor fault indications, activation of the F1-F2-ALARM-TRIP alarms.



CH	VALUE	LABEL	TEMPERATURE & ALARM						
			FCD	FOC	FCC	F1	F2	ALR	TRP
1	26 °C	CH1	•	•	•	•	•	•	•
2	27 °C	CH2	•	•	•	•	•	•	•
3	NO °C	CH3	•	•	•	•	•	•	•
4	27 °C	CH4	•	•	•	•	•	•	•
5	NO °C	CH5	•	•	•	•	•	•	•
6	27 °C	CH6	•	•	•	•	•	•	•
7	27 °C	CH7	•	•	•	•	•	•	•
8	NO °C	CH8	•	•	•	•	•	•	•



Key: **BACK**  
Return to the  
**HOME** screen

1	Indication channel CH1... .CH8	6	FCC signal ON red LED
2	Temperature channel CH1... CH8	7	F1 signal ON yellow LED (FAN1)
3	Channel reference label (*)	8	F2 signal ON yellow LED (FAN2)
4	FCD signal ON red LED	9	ALR signal ON red LED (ALARM)
5	FOC signal ON red LED	10	TRP signal ON red LED (TRIP)

(\*) the label indication can be customised by the user in the options - labels settings screen, see page 25.

## SETTINGS SCREEN

In the settings screen it is possible to modify the programming of the NT538 WS EVO control unit.



### SETTINGS

**Channel Settings**

1	2	3	4	5	6
CH	F1	F2	INT	ALR	TRP
1 <input checked="" type="checkbox"/>	<input checked="" type="checkbox"/>	<input checked="" type="checkbox"/>	<input type="checkbox"/>	90	119
2 <input checked="" type="checkbox"/>	<input checked="" type="checkbox"/>	<input checked="" type="checkbox"/>	<input type="checkbox"/>	90	119
3 <input type="checkbox"/>	<input checked="" type="checkbox"/>	<input checked="" type="checkbox"/>	<input type="checkbox"/>	90	119
4 <input checked="" type="checkbox"/>	<input checked="" type="checkbox"/>	<input checked="" type="checkbox"/>	<input type="checkbox"/>	90	119
5 <input type="checkbox"/>	<input checked="" type="checkbox"/>	<input checked="" type="checkbox"/>	<input type="checkbox"/>	90	119
6 <input checked="" type="checkbox"/>	<input checked="" type="checkbox"/>	<input checked="" type="checkbox"/>	<input type="checkbox"/>	90	119
7 <input checked="" type="checkbox"/>	<input checked="" type="checkbox"/>	<input checked="" type="checkbox"/>	<input type="checkbox"/>	90	119
8 <input type="checkbox"/>	<input checked="" type="checkbox"/>	<input checked="" type="checkbox"/>	<input type="checkbox"/>	90	119

**Other Settings**

HFN (Fan Test) 7 0 h

FCD 8 0 °C/s

Voting 9 0

Fail Safe 10  ALR  TRP  FLT

F1 On 70 F1 Off 60

F2 On 45 F2 Off 35

Network Settings 13

E-mail Settings 14

Options 15

Save Settings PIN CODE: 16 17



Key: **BACK**  
Return to the  
**HOME** screen

1	Channel reference and enabling CH1-CH2-CH3-CH4-CH5-CH6-CH7-CH8	10	Enabling of FAILSAFE FUNCTION, Relay: ALARM-TRIP-FAULT
2	Channel FAN 1 Enabling CH1-CH2-CH3-CH4-CH5-CH6-CH7-CH8	11	FAN 1 limit programming boxes On and Off (from 0°C to 240°C)
3	Channel FAN 2 Enabling CH1-CH2-CH3-CH4-CH5-CH6-CH7-CH8	12	FAN 2 limit programming boxes On and Off (from 0°C to 240°C)
4	INTELLIFAN FUNCTION enabling Not available for NT538 WS	13	NETWORK SETTINGS key
5	ALARM limit programming box (from 0°C to 239°C)	14	E-MAIL SETTINGS key
6	TRIP limit programming box (from 1°C to 240°C)	15	OPTIONS button
7	HFN setting box (from 0h to 200 h) 0=function disabled	16	SAVE SETTINGS key
8	FCD setting box (from 0°C to 30°C) 0=function disabled	17	PIN CODE box (*)
9	Voting setting box: (0-NO) (1-2-3) see voting on page 16.		

As for the panel programming also for programming through WEB SERVER it is necessary to follow these rules:

AL. = ALARM  $\geq$  TRIP

FAN = FAN-OFF  $\geq$  FAN-ON. (FAN1 OR FAN2)

The cells of the editable values are accessible in white, the grey cells are not accessible. The programming limits of the monitored parameters are shown in the table above.

**SAVE SETTINGS** key

Save Settings

PIN CODE:

After entering the PIN CODE, default 00000, by pressing the **SAVE SETTINGS** key the user updates the programming data of the NT538 WS EVO device. The control unit will lose the connection for a few seconds, the device will reset after which the new values will be available on the updated screen.

Incorrect programming of the device will result in the display of an error POP UP window with the relative signalling; the data update will not be processed.

(\*) Note: PIN CODE settings and operation on page 29.



### ATTENTION:

We recommend you check the device's programming before starting the device.

The default parameters set by TECSYSTEM might not match your requirements.

Programming the device is the end user's responsibility. The settings of the alarm thresholds and enabling of the functions described in this manual must be checked (by a specialist engineer) according to the application and features of the system the control unit is installed on.

NETWORK SETTINGS key

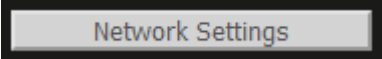

Pressing the NETWORK SETTINGS button the user accesses the Wireless network setting screen. In this screen the user can select the STATION or ACCESS POINT operating mode and set the network parameters.

#### WIRELESS MODE

it allows the user to select the operating mode.

**STATION:** the web server is connected via WI-FI to a pre-established network.

**ACCESS POINT:** the device works in the indicated mode, creating its own independent Wi-Fi network.

#### STATION MODE SETTINGS

Setting of the defined network parameters to which the control unit is connected.

#### ACCESS POINT MODE SETTINGS

Setting of network parameters: **SSID** network name) and **Password** of the network to which the control unit is connected.

**NOTE:** For information / clarifications regarding the Wi-fi network connection, contact your IT MANAGER.

1 Selection STATION mode settings			
2	Static IP address	5	Wi-Fi network name (Wi-Fi network on which to connect the device)
3	Default gateway	6	Wi-Fi network password (SHOW for password verification)
4	Subnet mask	7	Server NTP address (automatic time and date update)
1 Selection ACCESS POINT mode settings			
8	Access Point SSID (default TECSYSTEM) (network name modification)	9	Password (TECSYSTEM default) (SHOW for password verification)

After entering the **PIN CODE**, default 00000, press **SAVE** to save the set values. A POP UP window will confirm the correct saving of data.

Note: PIN CODE settings and operation on page 29.



Press **BACK** to return to the previous screen

**OPTIONS button**

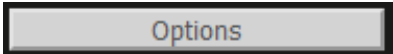

Pressing the **OPTIONS** button accesses the options screen. On this page it is possible to: set the date and time in the Access Point mode, select the sampling interval, customise the labels (labels) station and channels and set the username and password useful to access the web server.

**Set data/time (AP mode):** it allows the user to manually set the date and time in AP mode. This information is essential for correct operation of the control unit.

**Temperature Sampling Interval.**  
The sampling interval represents the waiting time between one recording and the next, a 15 minute pre-set fixed value.

**Event log**  
√ FAN ON / OFF event log enabling flag.  
NOTE: when the FAN event is enabled, the maximum recording limit, 10,000 events, may be reached early.  
√ TRIP event log enabling flag when the TRIP threshold is reached.

**Labels**  
The labels are used to customise, as desired, identification of the control unit and of the individual channel.

**The Web Access Credentials setting**  
It is used to set **username** and a **password**. Upon each log in to the web server, a POP-UP credential window will appear.



<b>1</b>	<b>Date and time setting in mode Access point mode</b>	<b>2</b>	<b>Sampling frequency 15 minutes</b>
<b>Events</b>			
<b>3</b>	<b>Include FAN ON / OFF log records</b>	<b>4</b>	<b>Include TRIP achievement log records</b>
<b>Labels</b>			
<b>5</b>	<b>Station Name label</b>	<b>10</b>	<b>Label channel 5</b>
<b>6</b>	<b>Label channel 1</b>	<b>11</b>	<b>Label channel 6</b>
<b>7</b>	<b>Label channel 2</b>	<b>12</b>	<b>Label channel 7</b>
<b>8</b>	<b>Label channel 3</b>	<b>13</b>	<b>Label channel 8</b>
<b>9</b>	<b>Label channel 4</b>		
<b>Web Access Credentials (setting of Username and Password for Web Server access)</b>			
<b>14</b>	<b>Username</b>	<b>15</b>	<b>Password (SHOW for password verification)</b>

After entering the **PIN CODE**, default 00000, press **SAVE** to save the set values. A **POP UP** window will confirm correct saving of the data.

Note: PIN CODE settings and operation on page 29.



Press **BACK** to return to the previous screen

**E-MAIL SETTINGS key**

E-mail Settings

Pressing the **E-MAIL SETTING** button accesses the E-MAIL screen. On this page it is possible to set the email account from which to send alarm notifications and reports. Furthermore, again on the same page, it is possible to select the predefined events for sending emails and the periodic deadline for sending reports.

**NOTE: with the aim of managing reports via e-mail we suggest the creation of a dedicated e-mail account. To ensure a high level of compatibility we suggest the GOOGLE e-mail account, activation of the security section, access to external APPs.**

**E-mail sender address:** e-mail address from which alarm notifications and reports are to be sent

**Outgoing e-mail (SMTP) server:** address of the mail server from which to send alarm notifications and reports

**SMTP server port:** set the communication port with the SMTP server

**Security flags:**  
 ✓ enabling SSL secure connection check, if provided by the mail account.  
 ✓ authentication control enabling

**Username:** username of the sender email account e-mail.

**Password:** default password of the email sender email account

**E-mails recipient's 1 address:** email address of recipient 1 for alarm notifications and reports

**E-mails recipient's 2 address:** e-mail address of recipient 2 for alarm notifications and reports.

**Periodic e-mail report:** represents the selection for the periodic deadline for sending reports.  
 Selection:  
 Disabled  
 Daily  
 Weekly  
 Monthly

**Test Mail:** by pressing the SEND key it is possible to send a test mail to the set addresses.

**E-mails activation event:** they represent the predefined events for which to send an e-mail notification.  
 Selection via flag ✓:  
 System restarted (control unit restart)  
 Setting saved (control unit programming)  
 Real time clock sync error (wi-fi network disconnection)  
 ALARM events (ALARM threshold exceeded)  
 TRIP events (TRIP threshold exceeded)  
 FAULT events (FAULT signalling)

<b>1</b>	<b>E-mail sender address</b>	<b>7</b>	<b>Password</b>
<b>2</b>	<b>Outgoing e-mail (SMTP) server</b>	<b>8</b>	<b>E-mails recipient's 1 address</b>
<b>3</b>	<b>SMTP server port</b>	<b>9</b>	<b>E-mails recipient's 2 address</b>
<b>4</b>	<b>Security flags</b>	<b>10</b>	<b>E-mails activation events</b>
<b>5</b>	<b>Security flags</b>	<b>11</b>	<b>Periodic e-mail report</b>
<b>6</b>	<b>Username</b>	<b>12</b>	<b>Test Mail</b>

After entering the **PIN CODE**, default 00000, press **SAVE** to save the set values. A **POP UP** window will confirm correct saving of the data.

Note: PIN CODE settings and operation on page 29.



Press **BACK** to return to the previous screen

## TREND CHART SCREEN

The **trend chart** screen allows the user to view the temperature trends of the enabled channels CH1-CH2-CH3-CH4-CH5-CH6-CH7-CH8, and it is also possible to export the values recorded on the CSV file.

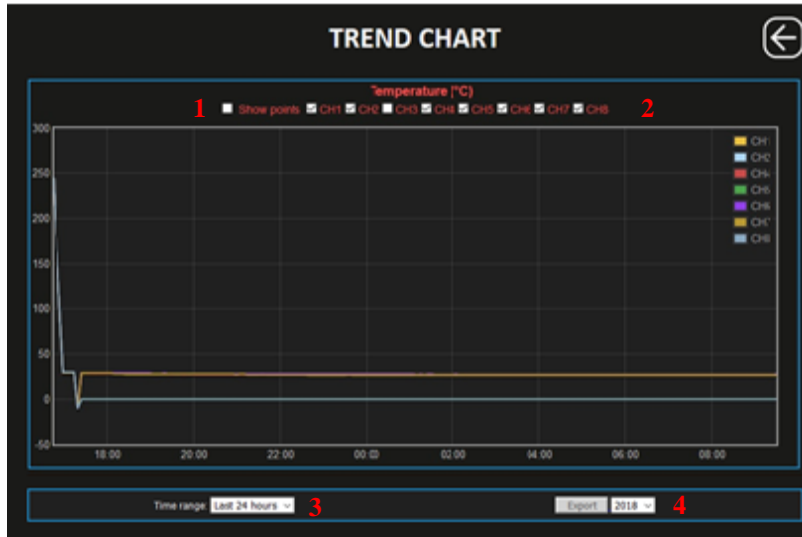
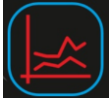

Key: **BACK**  
Return to the  
**HOME** screen

1	Recording points display flag	3	Time range
2	CHn channel enabling flag	4	Export key

### Recording points display flag

Enabling the recording points display flag it will be possible to identify each recording in the graph. Clicking on the individual point will show the information of: channel, date, time and recorded temperature value.

CH2: 15/7/2020, 16:20:00 72°C

### CH channel selection flag

Enable / disable the graphic display of the individual CHn channel.

### Time Range

Time range: Last 24 hours ▾

Allows the user to set the graphic display period available in the following selections:

- Last 24 hours
- Last 7 days
- Last 30 days

The trend display, channel temperatures, will be updated according to the selection of the chosen period and the enabled channels.

### EXPORT key

Export

By pressing the EXPORT key it is possible to download all the recorded temperature values in CSV format (text file). Before pressing the export button, select the year you want to export. CSV file export notes on page 29.

## EVENTS LOG SCREEN

The Event log screen is used to quickly obtain an immediate overview of the events recorded by the control unit. Each event is identified with ID code, see event ID table.



Key: **ORDER**  
It is used to organise the order of events according to the display requirements.

ID #	DATE/TIME #	DESCRIPTION	CH #	VALUE #
R05	15/7/2020, 14:12:14	ALARM OFF	3	72 °C
R06	15/7/2020, 14:11:48	TRIP OFF	3	73 °C
W04	15/7/2020, 14:11:43	undefined		
S06	15/7/2020, 14:10:50	TRIP ON	3	74 °C
S05	15/7/2020, 14:10:26	ALARM ON	3	73 °C
W04	15/7/2020, 14:10:21	undefined		
S03	15/7/2020, 14:09:57	FAN 1 ON	3	71 °C
I01	15/7/2020, 14:05:08	REAL-TIME CLOCK SYNC OK		
I05	15/7/2020, 14:04:25	WIFI CONNECTED		
I03	15/7/2020, 14:04:22	WIFI STATION MODE STARTED		
I00	15/7/2020, 14:04:21	SYSTEM RESTARTED		
R05	15/7/2020, 13:51:32	ALARM OFF	3	72 °C
S05	15/7/2020, 13:50:20	ALARM ON	3	73 °C
W04	15/7/2020, 13:50:06	undefined		
S03	15/7/2020, 13:49:35	FAN 1 ON	3	71 °C
R03	15/7/2020, 13:44:08	FAN 1 OFF	3	49 °C
R05	15/7/2020, 13:36:08	ALARM OFF	3	72 °C
S05	15/7/2020, 13:34:46	ALARM ON	3	73 °C
W04	15/7/2020, 13:34:41	undefined		
S03	15/7/2020, 13:34:12	FAN 1 ON	3	71 °C
R03	15/7/2020, 13:28:46	FAN 1 OFF	3	49 °C
R05	15/7/2020, 13:20:44	ALARM OFF	3	72 °C
S05	15/7/2020, 13:19:23	ALARM ON	3	73 °C



Key: **BACK**  
Return to the **HOME** screen

1	Export key	4	Description
2	Events ID	5	Event channel numbering
3	Date/ Time	6	Temperature value recorded

EXPORT button

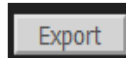

By pressing the **EXPORT** key it is possible to download all the recorded events in CSV format (text file) see notes on page 29.

### ID events table

Code	Message	Description
I00	System restarted	web server start
I01	Real time clock sync	Automatic setting date and time via sync server
I02	Login successful	web server access
I03	web server in STATION mode start	Start mode web server in STATION
I04	Wi-Fi Access point started	web server in ACCESS POINT mode start
I05	Wi-Fi connected	Web server connected to the Wi-Fi network
I06	Setting saved	Control unit parameters saving (PRG)
I07	Temperature log saved to csv	Saving of temperature csv file
I08	Events log saved csv	Saving of events log csv file
W00	Wi-Fi not connected	Wi-Fi disconnected from the network
W01	Real time clock set to last saved	Reset of date and time, automatic, since the last saving
W02	Real time clock manually set	Manual date and time setting
W03	Diagnostic button pressed	The access point button has been pressed
W04	TRIP temperature reached	Achievement of the TRIP threshold on the identified CHn (option screen enabling flag)
R00	Fcc off	FCC OFF fault signal on CHn channel identified
R01	Foc off	FOC OFF fault signal on CHn channel identified
R02	Fcd off	FCD OFF fault signal on CHn channel identified
R03	Fan1 off	FAN1 OFF switch off signal on CHn channel identified
R04	Fan2 off	FAN2 OFF switch off signal on CHn channel identified
R05	Alarm off	ALARM OFF switch off signal on CHn channel identified
R06	Trip off	TRIP OFF switch off signal on CHn channel identified
S00	Fcc on	FCC ON fault signal on CHn channel identified
S01	Foc on	FCD ON fault signal on CHn channel identified
S02	Fcd on	FCD ON fault signal on CHn channel identified
S03	Fan1 on	FAN1 ON activation signal on CHn channel identified
S04	Fan2 on	FAN2 ON activation signal on CHn channel identified
S05	Alarm on	ALARM ON activation signal on CHn channel identified
S06	Trip on	TRIP ON activation signal on CHn channel identified
E00	Modbus error	Modbus error signal
E01	Internal error	Signal internal web server error
E02	Log index recovered	Signalling of events log indices reset
E03	Log index cleared	Report deletion of events log indices

### TREND CHART NOTES

When the graphs page is opened, the last seven days recorded are displayed by default; if seven days are not available in the memory, all the available data are displayed.

The time range allows the user to set the graphic display period. The available selections are: last 24 hours, last 7 days and last 30 days.

### CSV FILE EXPORT NOTES

After exporting the CSV file for **EVENT LOG**, all the recorded events are exported, up to 10,000 events. Timing recording with UTC date and time (coordinated universal time).

After exporting the CSV file **TEMPERATURE VALUES**, it will be possible to select the year to be exported. The data contained available are the last 10 years recorded. The data export will be divided into years starting from activation of the device; if there is less than one year in the memory, all the available data are exported. Timing recording with UTC date and time (coordinated universal time).

### PIN CODE

The **PIN CODE** is a five-digit user-programmable code to confirm the user's intention to change device programming or network settings. It represents the parameter modification key reserved for the system manager. It limits any risks of unauthorised modifications or programming errors.

Without the **PIN CODE** or with the incorrect PIN, programming of the device cannot be changed.

#### How to change the PIN CODE:

**Turn off the device and turn it on again by keeping the access point button on the back pressed for approximately 2 seconds.**

Connect to the device and enter the IP address on the browser screen [http:// XXX.XXX.XX.XXX /setpin.html](http://XXX.XXX.XX.XXX/setpin.html)

Example:  

(IP ADDRESS)

Press **ENTER** and the **SET PIN CODE** screen will open.

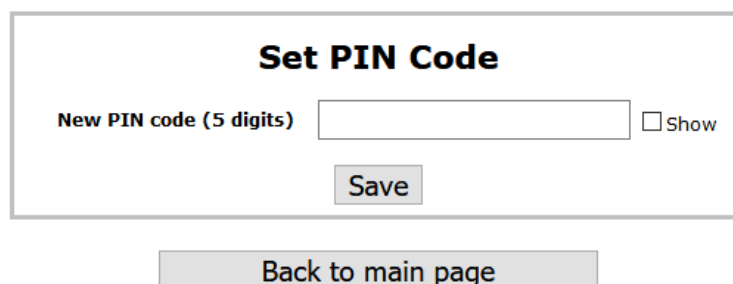

**Set PIN Code**

New PIN code (5 digits)   Show

Save

Back to main page

Type the new desired pin code in the appropriate box, maximum 5 numbers (**SHOW to display the PIN CODE**).

Press **SAVE** to save the pin A POP UP window will confirm the correct saving.

PIN CODE default setting: **00000**

Press **BACK to main page** to return to the main screen

**STATISTICS SCREEN**

The **STATISTICS** screen allows the user to view a statistical summary of the enabled channels CH1-CH2.... CH8, on the performance of the individual channel. Information (data) available for the user: max CH temperature, minimum CH temperature, delta T (MAX-MIN), average temperature, number of hours on FAN1 activation, number of hours on FAN 2 activation, ALARM threshold exceeded count, TRIP threshold exceeded count.



Data available in the time periods:

- Today
- Yesterday
- Current week
- Last week
- Current Month
- Last Month

STATISTICS									
Today									
1	2	3	4	5	6	7	8	9	
Channel	T max	T min	Delta T	T avg	Fan1	Fan2	Alarm cnt	Trip cnt	
1	42	35	7	38.4	00:00	00:00	0	0	
2	73	48	25	60.9	09:23	00:00	57	0	
3	47	37	10	41.5	00:00	00:00	0	0	
4	0	0	0	0.0	00:00	00:00	0	0	
5	41	35	6	38.3	00:00	00:00	0	0	
6	73	48	25	60.9	15:20	00:00	95	0	
7	47	37	10	41.5	00:00	00:00	0	0	
8	0	0	0	0.0	00:00	00:00	0	0	

Yesterday									
Channel	T max	T min	Delta T	T avg	Fan1	Fan2	Alarm cnt	Trip cnt	
1	41	35	6	38.3	00:00	00:00	0	0	
2	73	48	25	60.9	15:20	00:00	95	0	
3	47	37	10	41.5	00:00	00:00	0	0	
4	0	0	0	0.0	00:00	00:00	0	0	



Key: **BACK**  
Return to the **HOME** screen

<b>1</b>	Channel number	<b>6</b>	number of hours FAN 1 activation
<b>2</b>	CH max temperature	<b>7</b>	number of hours FAN 2 activation
<b>3</b>	CH min temperature	<b>8</b>	ALARM threshold exceeded count
<b>4</b>	Delta T (MAX-MIN)	<b>9</b>	TRIP threshold exceeded count
<b>5</b>	CH average temperature		

**PERIODIC REPORT**

By configuring the e-mail settings, e-mail setting on page 26, it will be possible to receive a periodic report on the operation of each channel.

The data contained in the report will be those displayed on the statistics page, see the example below:

**Today**

Channel	T max	T min	Delta T	T avg	Fan1	Fan2	Alarm cnt	Trip cnt
1	42	35	7	38.4	00:00	00:00	0	0
2	73	48	25	60.9	09:41	00:00	60	0
3	47	37	10	41.6	00:00	00:00	0	0
4	0	0	0	0.0	00:00	00:00	0	0
5	42	35	7	38.4	00:00	00:00	0	0
6	73	48	25	60.9	09:41	00:00	60	0
7	47	37	10	41.6	00:00	00:00	0	0
8	0	0	0	0.0	00:00	00:00	0	0

Report sending selection:

- Disabled
- Daily
- Weekly
- Monthly

**What is the periodic report for?**

It can be used to automatically receive an update on the operation of the monitored electric machine, without wasting any time. By analysing the periodic reports received, directly on their own e-mail, the maintenance technicians will be able to identify any anomalies and plan in advance the interventions on the systems

TROUBLESHOOTING	CAUSES AND SOLUTIONS
The control unit does not switch on and the supply to terminals 40-42 is correct.	Check that: the connector is firmly inserted in its place, the connection wires are tight and that there are no obvious signs of burns on the connectors. Turn off the power supply and carry out the above instructions, restore the voltage.
One of the channels is in FAULT for FOC/FCC	Check the connections of the Pt100 probes, check the indications provided in the paragraphs: <i>transport of measurement signals and diagnostics of thermometric probes on page 14-15.</i>
When turned on, the indication "ECH" appears	A strong disturbance has damaged the memory data. See the paragraph for programmed data diagnostics on page 16.
All the Pt100 sensors are in FCC.	Incorrect sensor connection, the terminal block has been inserted upside down. <i>Check the connections and the terminal board.</i>
The temperature shown by one or more channels is wrong.	Contact the <i>TECSYSTEM</i> Technical Department.
Sudden trip of the main switch. The temperature is on standard levels. Just one channel has caused the trip.	Check the temperatures recorded in T-MAX, check the indications provided in the paragraphs: <i>transport of measurement signals and diagnostics of thermometric probes page 16. Activate the FCD function.</i>
FCD warning	See the FCD function on page 19.
During operation of the web server it is not possible to display the date and time and also the graphics screen does not work.	In the <b>Access point</b> mode select settings/Options and enter the date and time in the <b>Set date/time (AP mode)</b> box In <b>Station</b> mode, select settings/Networking and enter time.google.com in the <b>Server NTP</b> box
The web server has been set in Access Point mode but the network cannot be identified.	With the control unit off, keep the access point button pressed, then power the device and release the button after approximately 5 seconds. The <i>TECSYSTEM</i> network (S/N + YEAR) will appear and connect to the network using the <i>TECSYSTEM</i> password. Open your browser and type in the address 192.168.8.8 use the web server bar to enter the Settings page, press the Network setting button and check: the ACCESS POINT selection, the settings SSID and Password, press save.
The web server has been set in Station mode but the web server cannot be accessed.	With the aid of a device with a Wi-Fi connection (PC, Smartphone or Tablet) with the control unit off, keep the access point button pressed, then power the device, and release the key after approximately 5 seconds. Launch the search for the Wi-Fi network from your device. The <i>TECSYSTEM</i> network will appear (S/N + YEAR), connect to the network using the <i>TECSYSTEM</i> password. Open your browser and type in the address 192.168.8.8, use the web server bar to enter the Settings, page, press the Network setting button and check: the STATION selection, the settings: IP – GATEWAY -SUBNET MASK – NET WORK SSID – PASSWORD, press save.
Contact the <i>TECSYSTEM</i> Technical Department if the problem persists.	

## WARRANTY REGULATIONS

The purchased Product is covered by the manufacturer's or seller's warranty under the terms and conditions indicated in the "Tecsistem s.r.l. General Sales Conditions", which can be consulted on the website [www.tecsystem.it](http://www.tecsystem.it) and/or in the stipulated purchase contract.

The warranty is considered valid only when the product is damaged by causes attributable to *TECSYSTEM* srl, such as manufacturing or components defects.

The warranty is invalid if the Product proves to have been tampered with/modified or incorrectly connected and causing voltages outside the set limits and does not comply with the technical data for use and assembly, as described in this instruction manual.

The warranty is always ex Corsico as stated in the "General Conditions of Sale".

## EQUIPMENT DISPOSAL

The European directive 2012/19/EU (WEEE) has been approved to reduce the waste of electrical and electronic appliances and to encourage the recycling and reuse of materials and components of these appliances, thereby reducing the disposal of harmful residues and compounds originating from electrical and electronic material.



All the electrical and electronic equipment supplied after 13 August 2005 is marked with this symbol, pursuant to European directive 2012/19/EU on electrical and electronic waste (WEEE). Any electrical or electronic equipment marked with this symbol must be disposed of separately from normal domestic waste.

Returning of used electrical appliances: contact TECSYSTEM or the TECSYSTEM agent to receive information on correct disposal of the appliances.

TECSYSTEM is aware of the impact its products have on the environment and asks its customers active support in the correct and environmentally-friendly disposal of its devices.

## USEFUL CONTACTS

TECHNICAL INFORMATION : [ufficiotecnico@tecsystem.it](mailto:ufficiotecnico@tecsystem.it)

SALES INFORMATION : [info@tecsystem.it](mailto:info@tecsystem.it)



## UL SPECIFICATION AND RATINGS

CABLE SPECIFICATION	Dimension for main circuit 18AWG, working temperature over 105°C
MASS OF THE EQUIPMENT	0,46 Kg
INPUT SUPPLY	85-260 Vac / Vdc ( $\pm 10\%$ ), 50/60 Hz, 7,5VA max
PROTECTION	External switch or circuit breaker
OUTPUTS RELAYS	5 relay output: 10A 250Vac-res COS=1
OPTIONAL PORTS	Wi-Fi

Suitable for use on a flat surface of a type 1 enclosure if back panel is provided with two short fixing screws tightening torque: 0.57Nm